

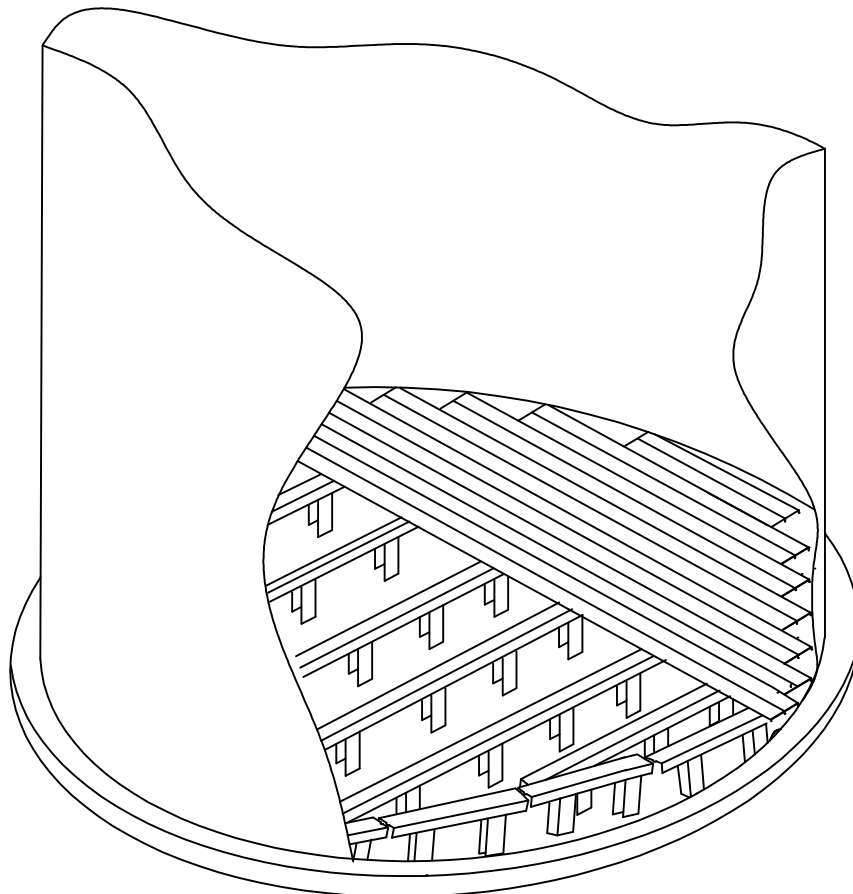

TYPICAL
FLOOR AND SUPPORT
INSTALLATION INSTRUCTIONS
FOR
CIRCU-LATOR AND DRI-FLO



SHIVERS MANUFACTURING
614 W. English Street
Corydon, IA 50060
Ph. (641) 872-1005 ** Fax (641) 872-1593
www.shivers.com

P-8629 Rev K
March 6, 2020

NOTE: PAGE INTENTIONALLY
LEFT BLANK

Shivvers' Floor and Floor Supports for Circu-Lator use are warranted for use with Shivvers' drying equipment. (If other brands are used, Shivvers will not be responsible for the Drying Floor or Support System should it happen to fail.)

NO EXPRESS WARRANTIES AND NO IMPLIED WARRANTIES, WHETHER OF MERCHANTABILITY OR FITNESS FOR ANY PARTICULAR USE SHALL APPLY TO ANY "SHIVVERS CHANNEL LOCK FLOOR" MANUFACTURED OR SOLD BY SHIVVERS INCORPORATED, IF SAID "SHIVVERS CHANNEL LOCK FLOOR" IS USED IN THE HANDLING OR STORAGE OF GRAIN WHERE THE DEPTH OF THE GRAIN IS IN EXCESS OF 30 FEET, AND NO WAIVER, ALTERATION, OR MODIFICATION OF THIS DISCLAIMER OF WARRANTY SHALL BE VALID.

This manual shows leg spacing for use with Shivvers Circu-Lator or Dri-Flo with a 16' maximum grain depth. For storage only bins, the leg spacing will be different.

For storage only floors, with depths up to 22', space all legs 34" apart throughout the bin, staggered from rail to rail.

For storage only floors, with depths up to 30', space all legs 20" apart throughout the bin, staggered from rail to rail.

SHIVVERS MANUFACTURING
614 West English
Corydon, Iowa 50060
Phone: (641) 872-1005 ** Fax: (641) 872-1593
www.shivvers.com

TYPICAL COMPONENTS

VALID FOR CIRCU-LATOR, DRI-FLO & STORAGE UP TO 30' DEEP ONLY

NOTE:

Use pop rivets in 349C-001A hardware sack.

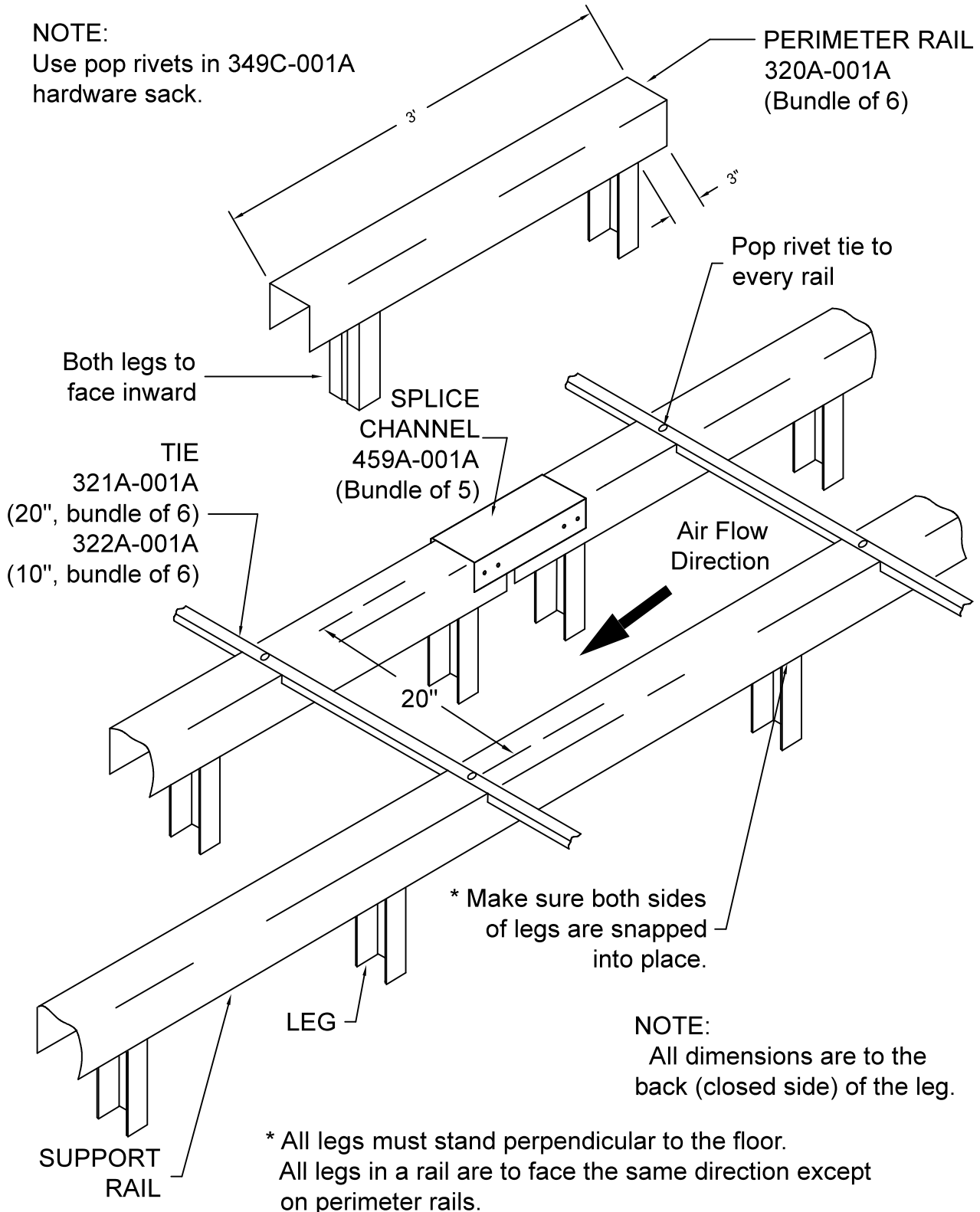

TYPICAL COMPONENTS

NOTE;

Some of the longer support rails on larger bins are made up of two or more shorter rails spliced together to make one long rail.

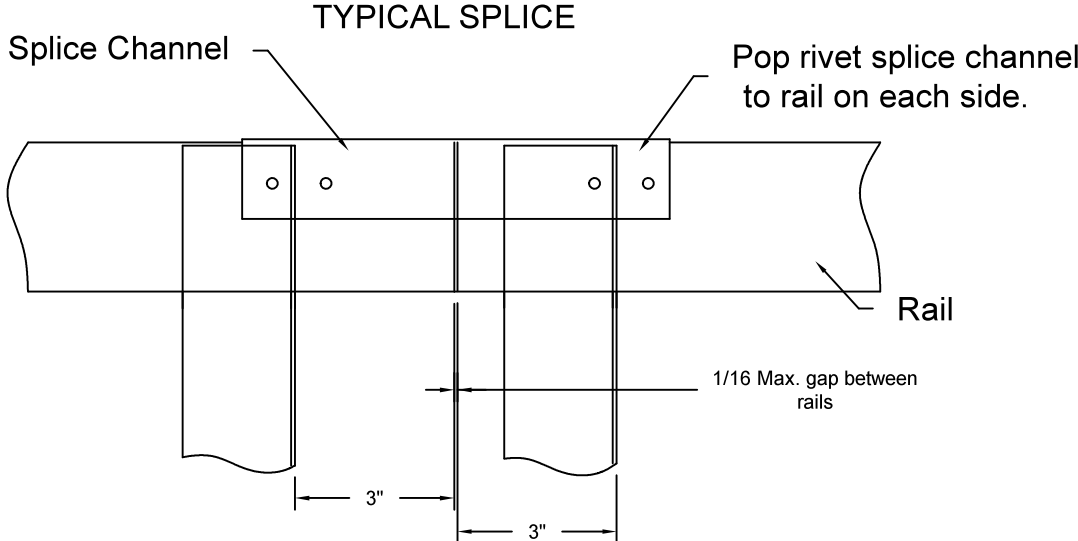

INSTALLING A LEG INTO A RAIL.

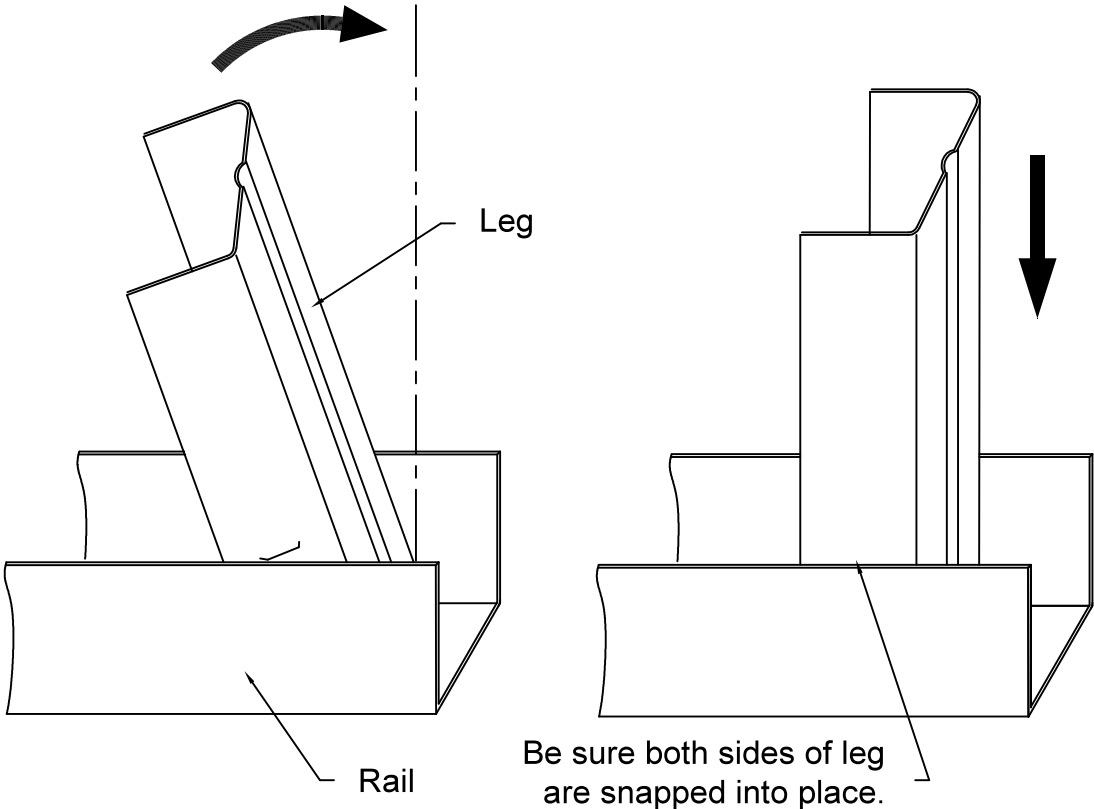

INSTALLATION PROCEDURE

STEP 1:

Verify that the gearbox and basket is in the center of bin. Lay out a circle in the center of bin using the square shaft in top of the gearbox as the center. For bins under 28' this circle will be a diameter of 1/2 the size of the bin, to the next highest foot. A bin of 18' diameter will have a 9' circle; a bin of 27' will have a 14' circle. For bins over 28' diameter, see the appropriate layout page for the diameter of the circle.

STEP 2:

Insert a leg 3" from each end of the 3' perimeter rails. Place perimeter rails end to end against the bin wall, starting each end at the unloader. There will be a gap remaining after these rails are set opposite the unloader. If the gap is more than 8" cut a perimeter rail to fit. Lay out support rails upside down and parallel to the unloader approximately where they will be used. These rails will be on 20" centers throughout the bin. The outside rail may be on a 10" center on some bins.

STEP 3:

Starting with the first rail from the center of the bin, place a leg 7 1/2" from the center of the rail. All legs should face the same direction with the opening away from the majority of the air flow. Then install legs on 15" centers to the circle layed out earlier. Then go to 30" centers on the rest of the rail. Outside of the circle where the legs are on 30" spacing, offset the legs from one rail to the next. If there is more than 8" overhang at the end of the rails, install another leg 3" from the end of the rail.

Extra legs should be placed in the circle marked earlier so that all legs inside this circle are on 15" centers.

On bins over 30' in diameter, some rails will be in two pieces. These rails must be joined by a splice channel and legs will be set on each side of the splice.

STEP 4:

Place legs in rails for 1/2 of the bin. Turn the first rail from the center right side up, parallel to the unloader tube, with the center rail 10" away from the center of the horizontal unloader tube. With this rail in position, set remaining rails on 20" centers and fasten with rail ties. These ties are cut for 20" centers. Some bins may require the outside rail to be on a 10" center. Rail ties cut for a 10" spacing will be provided. BE SURE TO RIVET TIES TO THE RAILS.

INSTALLATION PROCEDURE

STEP 5:

Use the same procedures on the second half of the bin. Outside the circle where the legs are on a 30" spacing, offset the legs from one rail to the next.

STEP 6:

Check to see that each rail and rail tie intersection is riveted, that each leg is securely locked into the rail, and that each leg is perpendicular to the rail. **CAUTION:** Angularity of the legs to the support rails other than 90° reduces the support capacity and stability of the floor supports. In other words, the legs must be square to the support rails. **BE SURE OF THE CORRECT LEG INSTALLATION BEFORE PLACING FLOOR PLANKS.** If the bin concrete is not level, shim up the legs as required, so the floor is level.

STEP 7: Shivvers Super Channel Lock Floor

Floors can be ordered for standard or small grain applications. The Standard Drying Floor has a hole design with .094" diameter holes on 3/16" staggered centers. The Small Grain Drying Floor has a hole design with .054" diameter holes on 7/64" staggered centers and is designed for rape seed or other small grains.

Starting with the shortest floor panel from bundle "A", place it at a right angle to the support rails at the outer edge of the bin, keeping the turned under edge toward the bin wall. Work toward the center of the bin, installing all the panels from bundle "A" progressing from the shortest to the longest. Be sure each panel is locked into the previous panel.

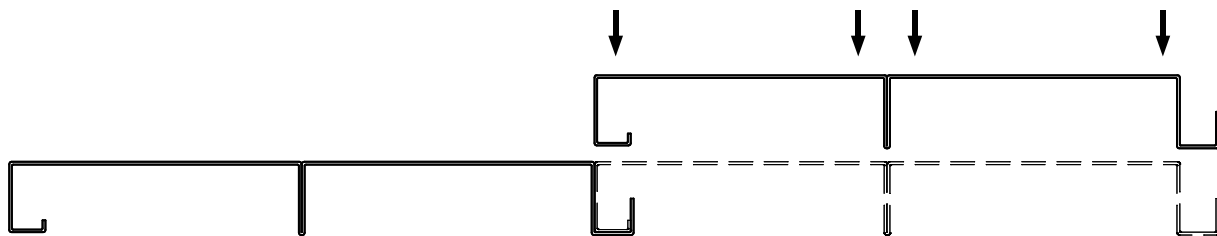

NOTE: Always place the floor panel under the gearbox basket flanges.

STEP 8: Bins under 30' 6" Diameter

Bundle "A" will complete the floor to the center of the bin. Install bundle "B" in reverse order to bundle "A", working from the longest panel to the shortest, finishing the second half of the bin.

INSTALLATION PROCEDURE

STEP 9: Bins over 30' 6"

On these larger diameter bins, after installing bundle "A" proceed with bundle "B" again working from shortest panel to the longest. Notice that panels longer than 30' 6" are furnished in two pieces that are bundled together to complete one row across the bin. Install all short panels on one side, and the matching long panels on the other. Keep the ends of these panels in a straight line centered on top of a support rail. On these floors with more than two bundles, the center of the bin will be in the center of the bundles. Example: Floor comes in bundles "A, B, C, D"--Bundles "A" and "B" will be one half of the bin floor, and bundles "C" and "D": will be the other half.

STEP 10: Floor Splice Plates

On floors over 30' 6" diameter, cover the joints at the end of the spliced floor panels using splice plates and pop rivets.

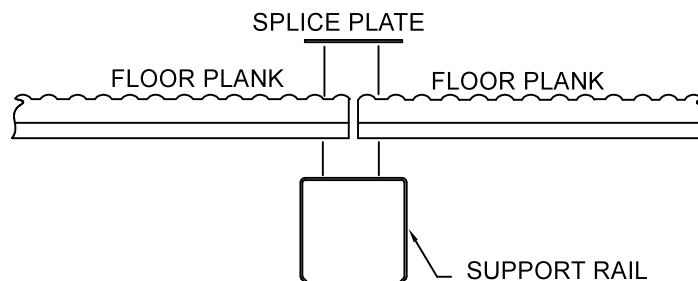
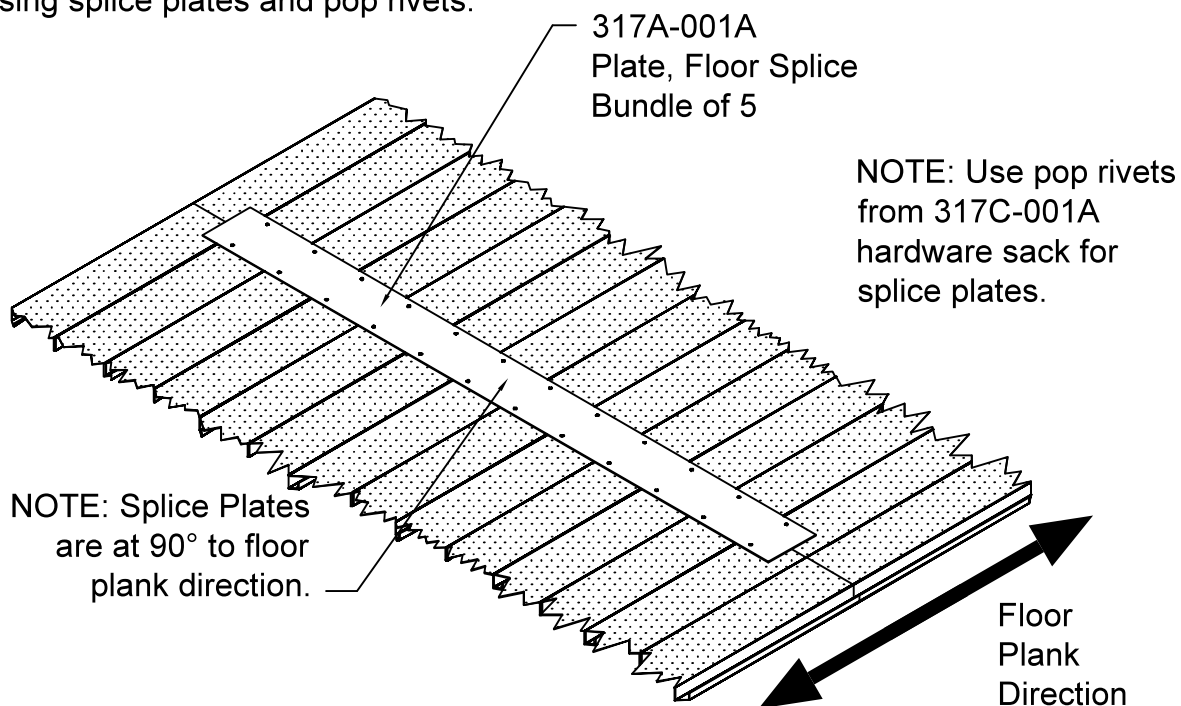

NOTE: All Floor Splices MUST be aligned on the top of Support Rail as shown.

INSTALLATION PROCEDURE

STEP 11:

When all flooring is installed, flashing should be installed starting anywhere around the perimeter installing in a clockwise direction around the bin. Bolt the flashing to the side wall. Attach the long leg of the flashing to the floor using pop rivets. Pop rivets must be used since metal screws will work loose and allow grain to leak into the plenum chamber.

For Circulator 1, if cleanout sweep will be used, install flashing in a counter-clockwise direction.

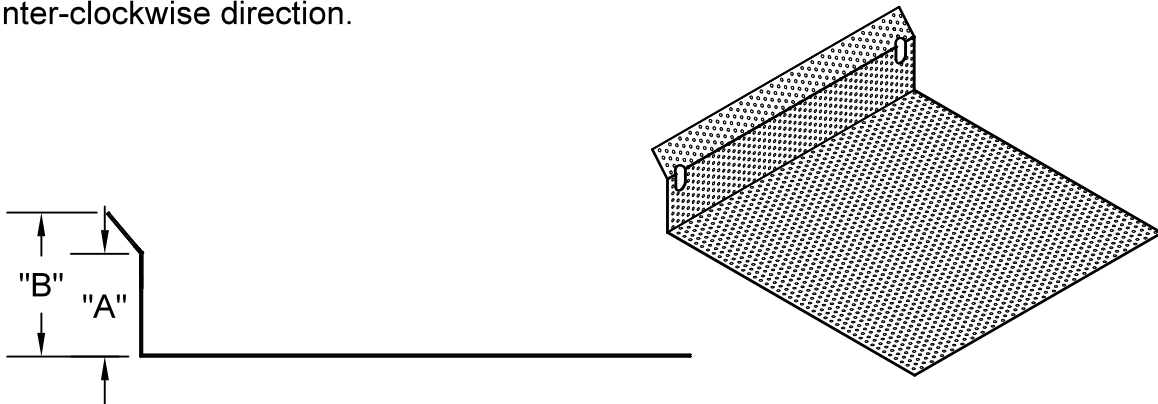

SHIVERS FLASHING

	"A" Dim	"B" Dim	Height Range (Bend to center of 3/8" Bolt)	
			Min.	Max.
L = Low	1.062"	2.125"	.812"	1.313"
M = Medium	1.75"	2.812"	1.5"	2"
H = High	2.375"	3.437"	2.125"	2.625"
XH = Extra High	3.312"	4.375"	3.062"	3.563"

Standard Flashing

	Low	Medium	High	Extra High
1 PC.	511-002P	511-003P	511-004P	511-005P
12 PCS.	511AA-001A	511BB-001A	511CC-001A	511DD-001A

Small Grain Flashing

	Low	Medium	High	Extra High
1 PC.	512-002P	512-003P	512-004P	512-005P
12 PCS.	512AA-001A	512BB-001A	512CC-001A	512DD-001A

LAYOUT OF PERIMETER RAILS, SUPPORT RAILS AND LEGS

(This is a typical layout)

VALID FOR CIRCU-LATOR & DRI-FLO ONLY

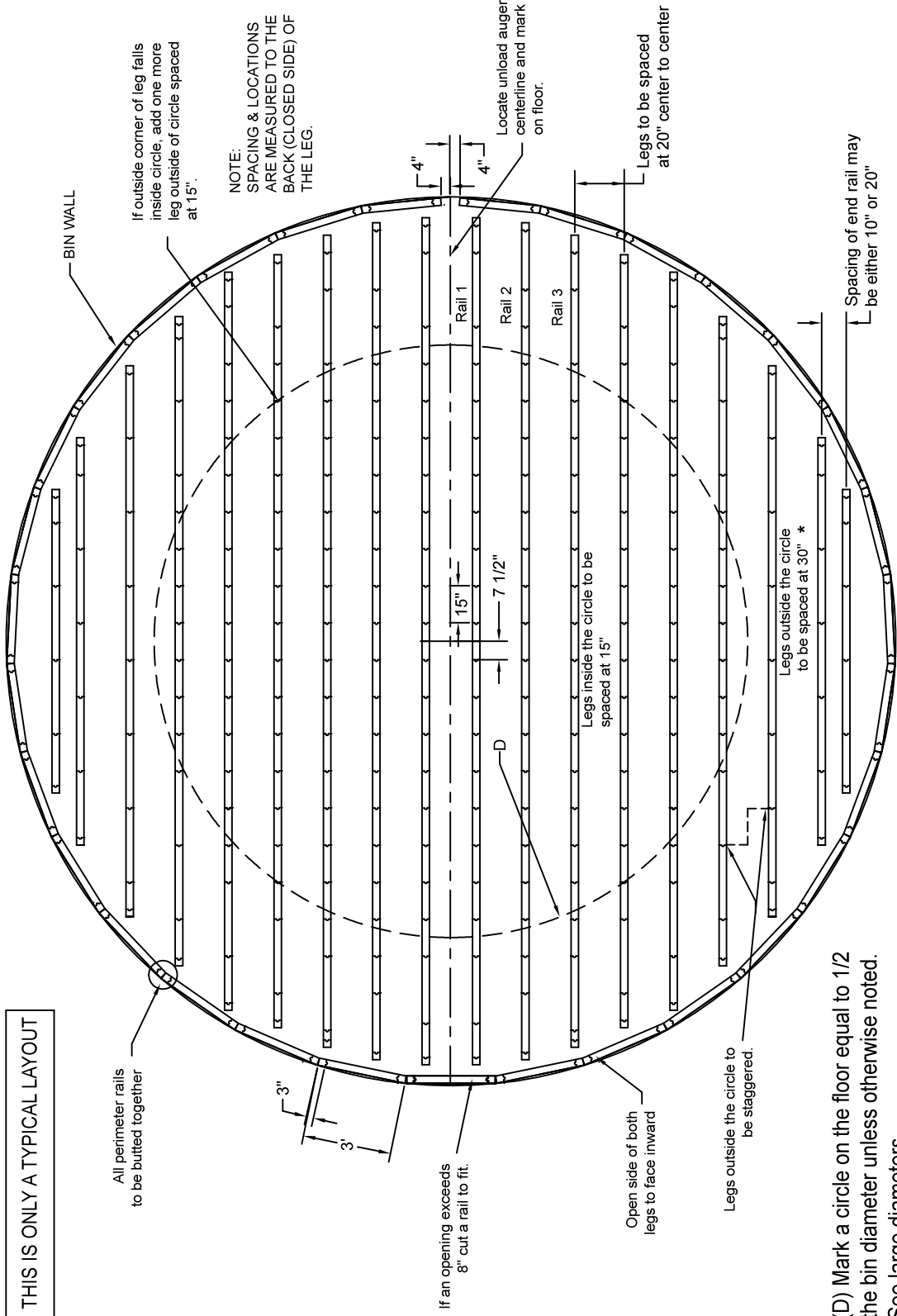

THIS IS ONLY A TYPICAL LAYOUT

(D) Mark a circle on the floor equal to 1/2 the bin diameter unless otherwise noted. See large diameters.

THE NUMBER OF LEGS SHOWN HERE MAY NOT BE THE SAME AS REQUIRED IN YOUR BIN

* NOTE: Shown is a typical layout valid for Circu-Lator or Dri-Flo only. For storage floors with depths up to 22', space all legs 34" apart throughout the bin. For storage floors with depths from 22' to 30', space all legs 20" apart throughout the bin.

THIS IS ONLY A TYPICAL LAYOUT

THE NUMBER OF TIES SHOWN HERE MAY NOT BE THE SAME AS REQUIRED IN YOUR BIN

TYPICAL CROSS TIE LOCATION

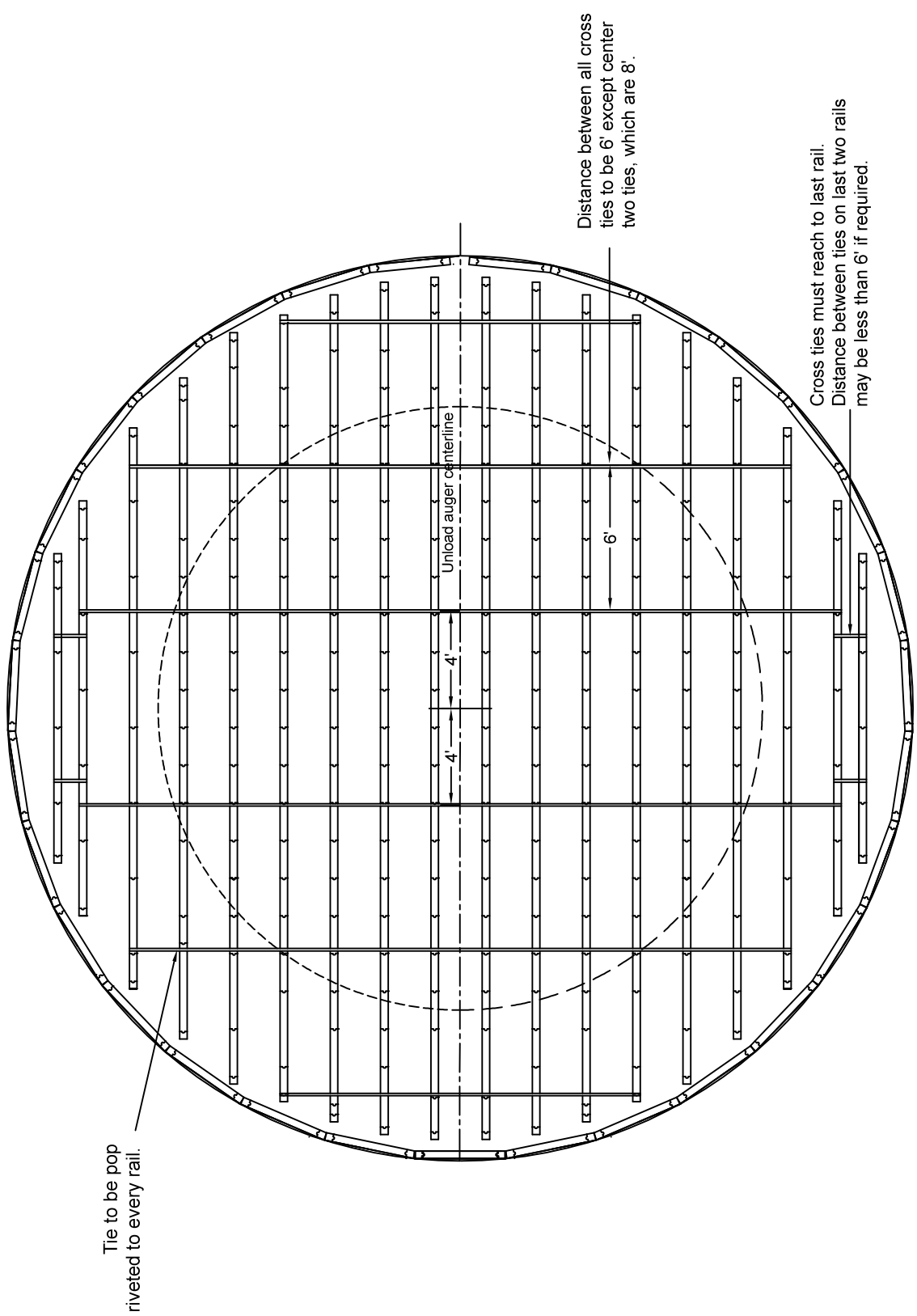

18' FLOOR

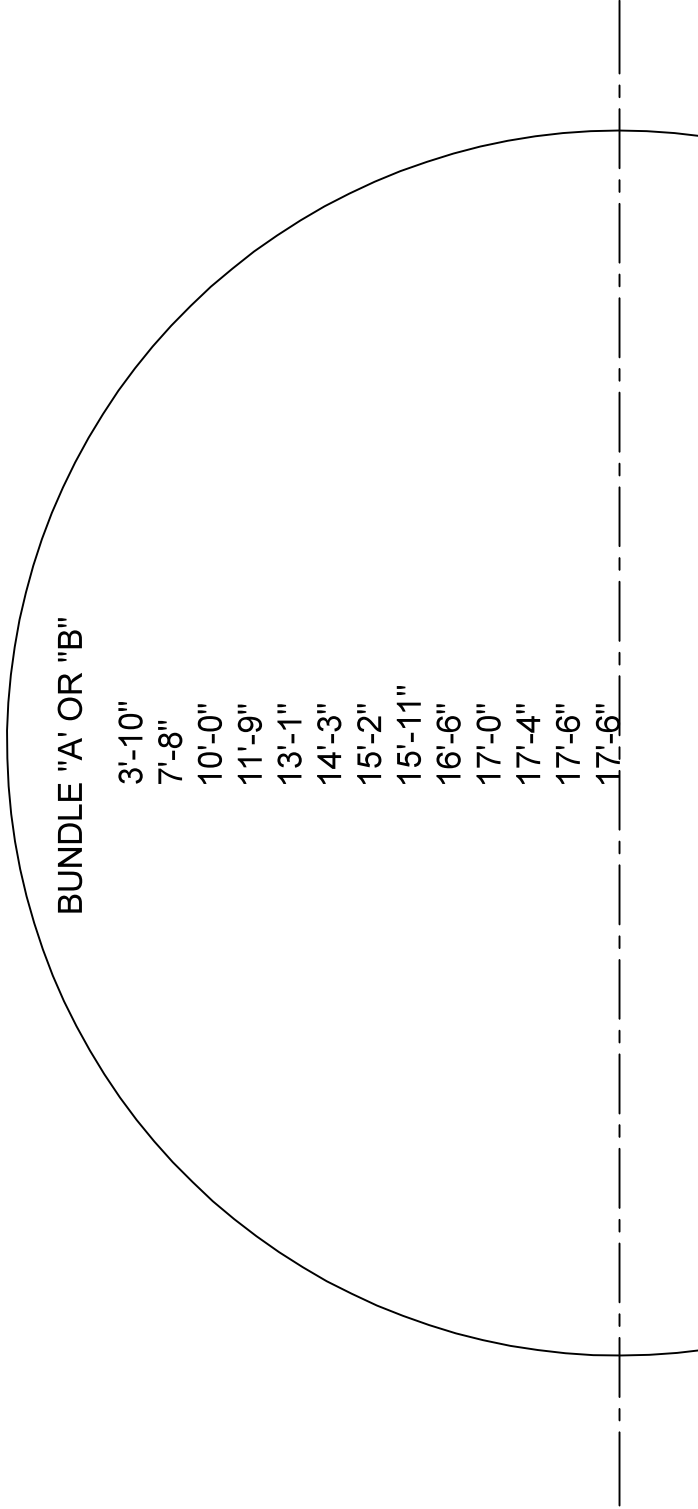

Bundle "B" is identical to Bundle "A"

- 26 Pieces per Bin
- 355 Feet of Flooring
- 595.69 Pounds total
- 6 Bundles of Flashing
- 6 Hardware Sacks for Flashing

18' FLOOR

OPEN SIDE OF LEGS
SHOULD ALWAYS BE IN
SAME DIRECTION, EXCEPT
ON PERIMETER RAILS.

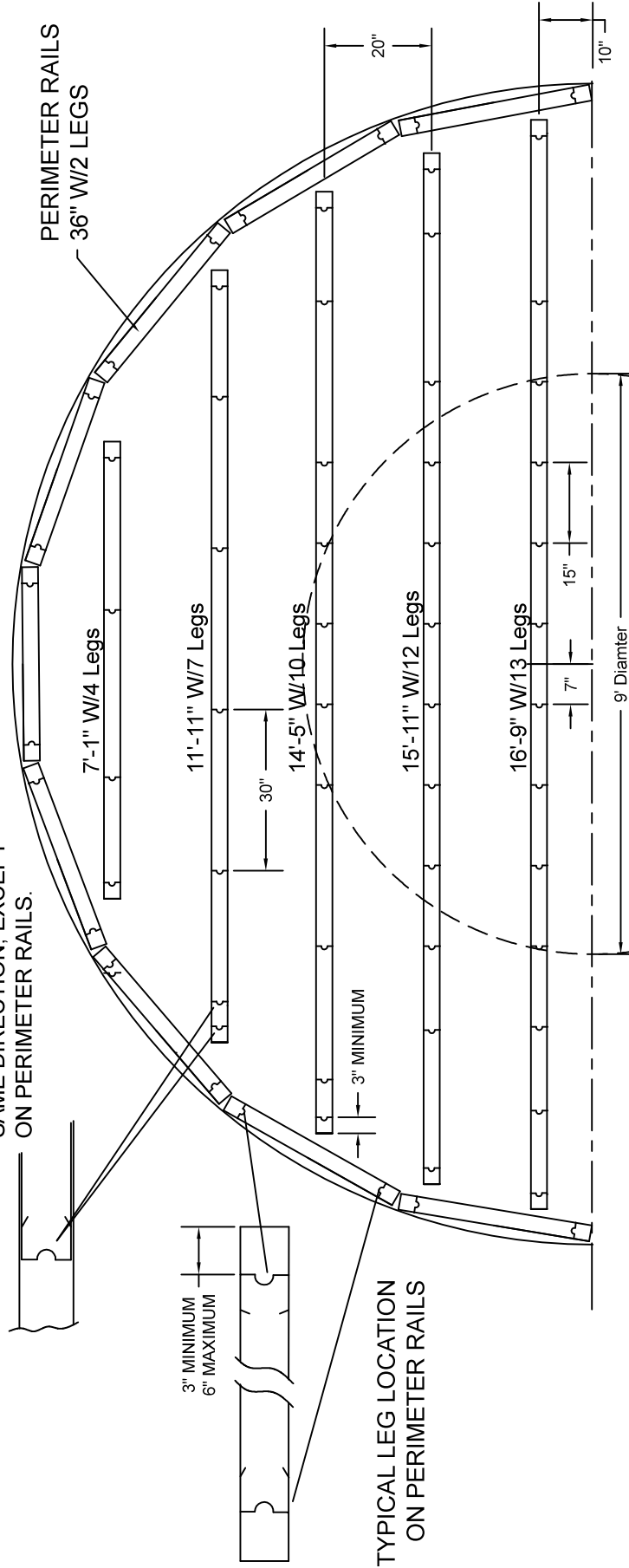

TYPICAL LEG LOCATION
ON PERIMETER RAILS

15" LEG SPACING INSIDE 9' CIRCLE
30" LEG SPACING OUTSIDE 9' CIRCLE.
LEGS AT 30" SPACING SHOULD BE STAGGERED.
(NOT LINED UP FROM RAIL TO RAIL.)

11 BUNDLES OF LEGS
3 BUNDLES OF PERIMETER RAILS
1 BUNDLE OF RAIL TIES AT 20" C-C
1 BAG OF POP RIVETS (50 PCS)

21' FLOOR

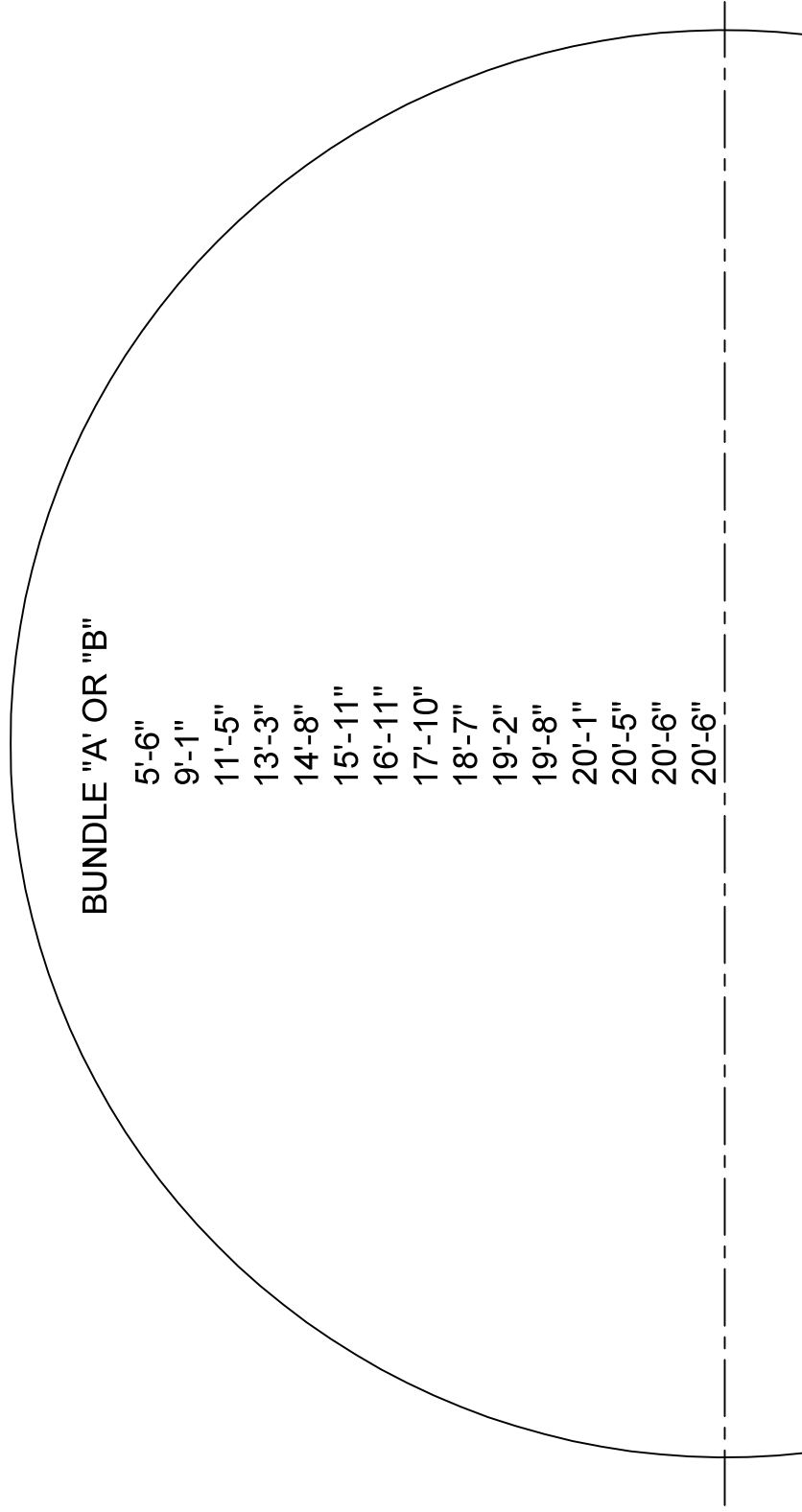

Bundle "B" is identical to
Bundle "A"

- 30 Pieces per Bin
- 487 Feet of Flooring
- 817.18 Pounds total
- 7 Bundles of Flashing
- 7 Hardware Sacks for Flashing

21' FLOOR

OPEN SIDE OF LEGS SHOULD ALWAYS BE IN SAME DIRECTION EXCEPT ON PERIMETER RAILS.

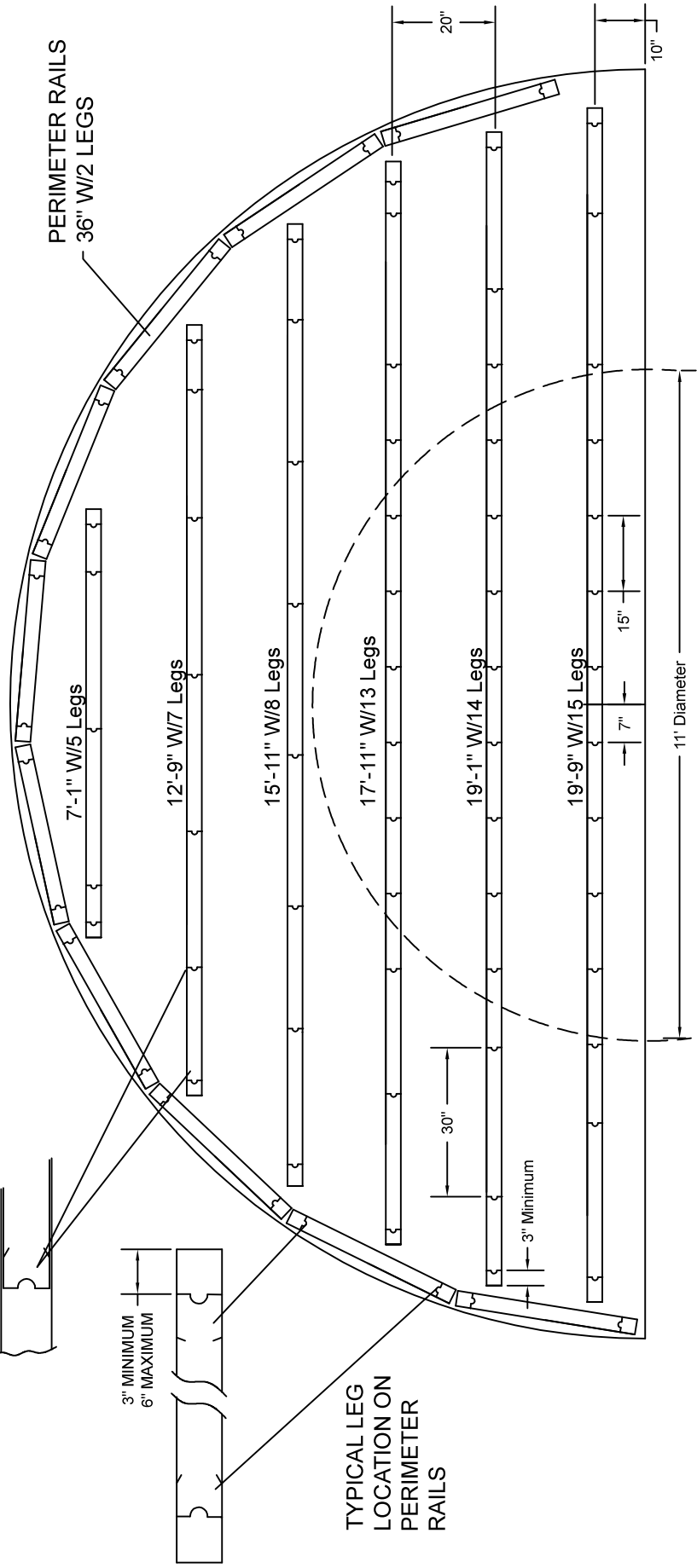

15" LEG SPACING INSIDE 11' CIRCLE
 30" LEG SPACING OUTSIDE 11' CIRCLE.
 LEGS AT 30" SPACING SHOULD BE STAGGERED.
 (NOT LINED UP FROM RAIL TO RAIL.)

14 BUNDLES OF LEGS
 4 BUNDLES OF PERIMETER RAILS
 2 BUNDLES OF RAIL TIES
 1 BAG OF POP RIVETS (50 PCS)

24' FLOOR

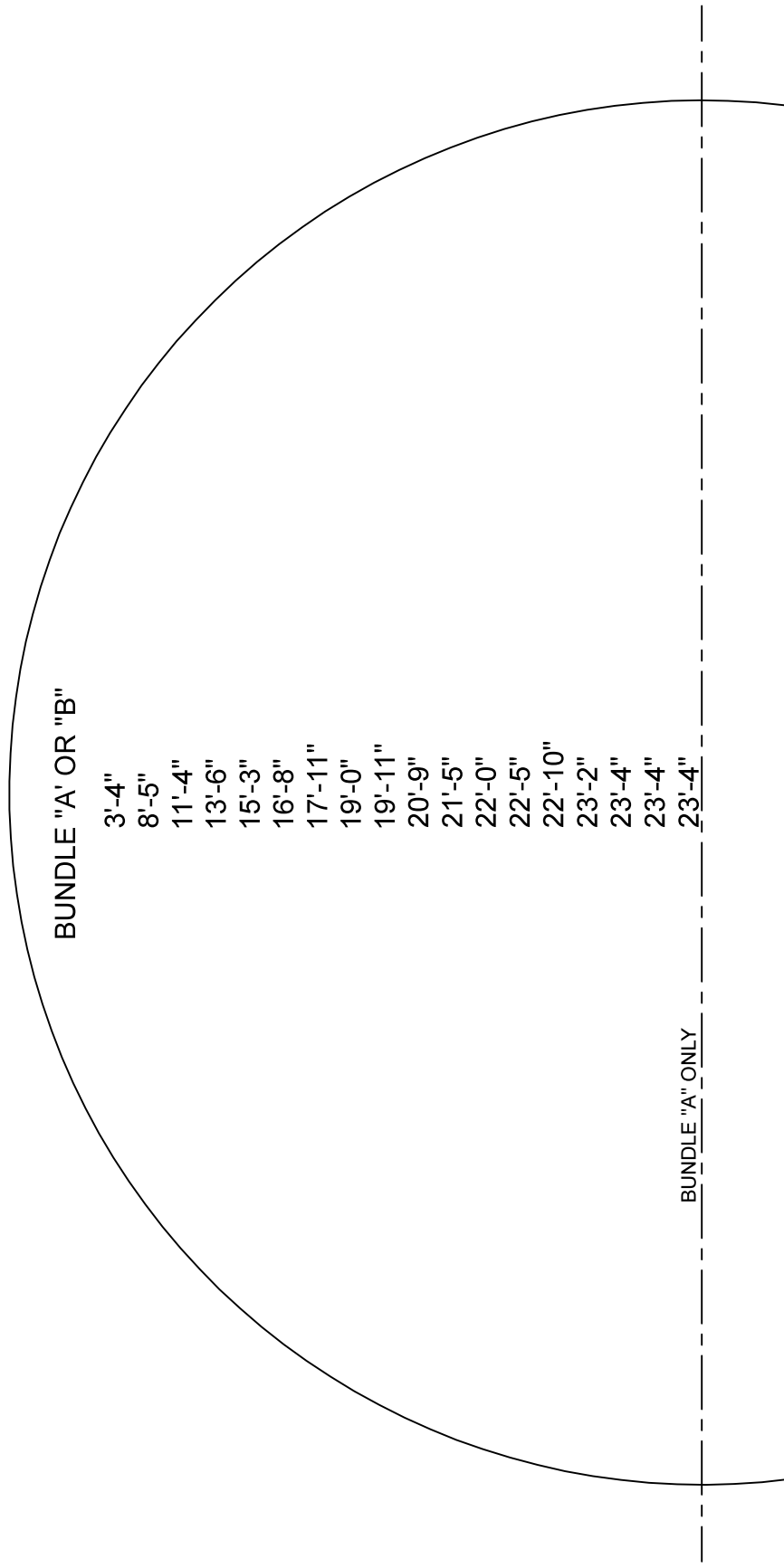

Bundle "B" is identical to Bundle "A" with exception of one piece of 23'-4" Length

- 35 Pieces per Bin
- 632.5 Feet of Flooring
- 1061.33 Pounds total
- 8 Bundles of Flashing
- 8 Hardware Sacks for Flashing

24' FLOOR

OPEN SIDE OF LEGS SHOULD ALWAYS BE IN SAME DIRECTION EXCEPT ON PERIMETER RAILS.

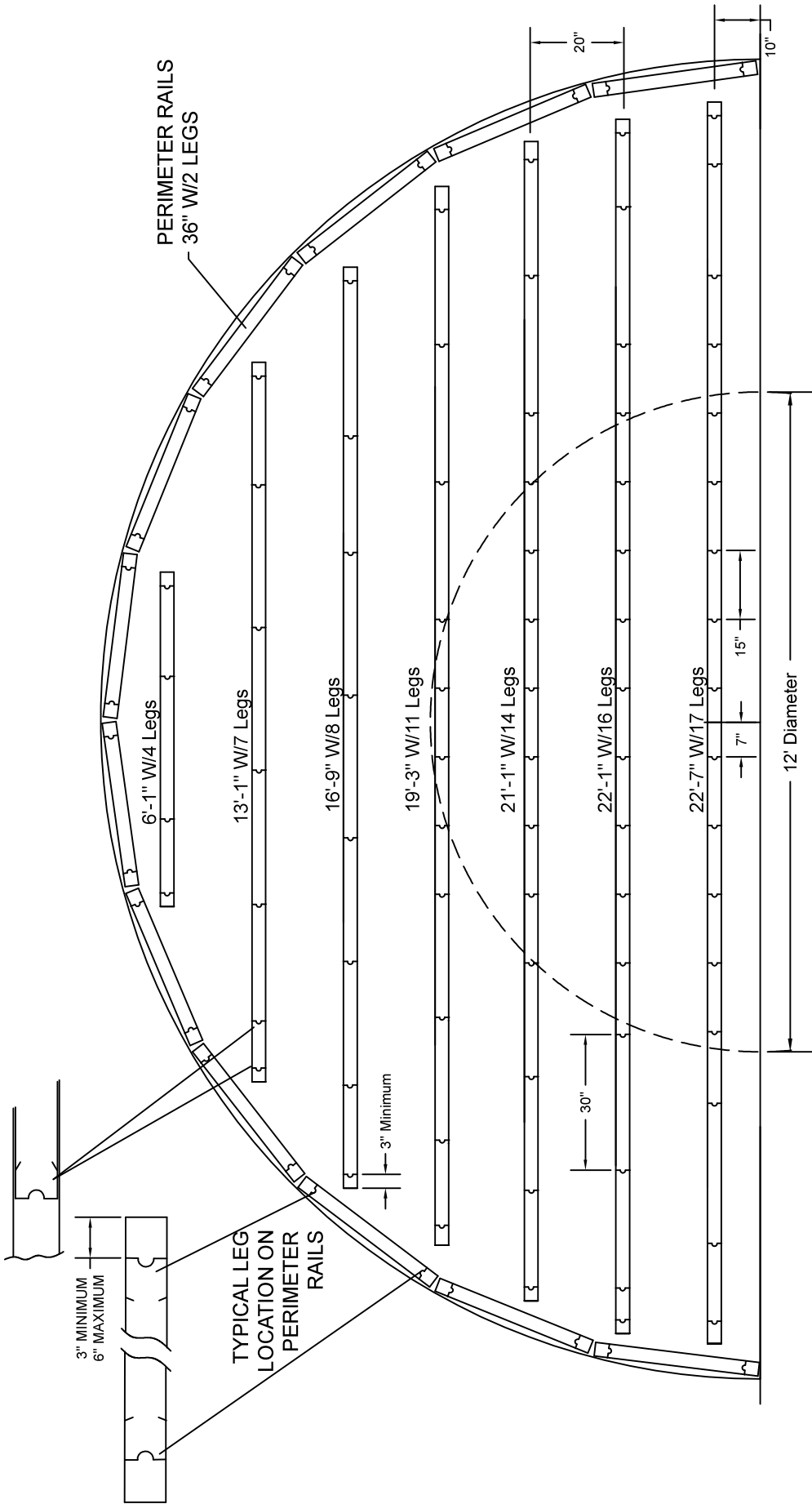

3" MINIMUM
6" MAXIMUM

TYPICAL LEG LOCATION ON PERIMETER RAILS

3" Minimum

30"

15"

7"

12' Diameter

10"

PERIMETER RAILS
36" W/2 LEGS

6'-1" W/4 Legs

13'-1" W/7 Legs

16'-9" W/8 Legs

19'-3" W/11 Legs

21'-1" W/14 Legs

22'-1" W/16 Legs

22'-7" W/17 Legs

- 17 BUNDLES OF LEGS
- 4 BUNDLES OF PERIMETER RAILS
- 3 BUNDLES OF RAIL TIES AT 20" C-C
- 2 BAGS POP RIVETS (100 PCS)

15" LEG SPACING INSIDE 12' CIRCLE
30" LEG SPACING OUTSIDE 12' CIRCLE.
LEGS AT 30" SPACING SHOULD BE STAGGERED.
(NOT LINED UP FROM RAIL TO RAIL.)

24'-9" FLOOR

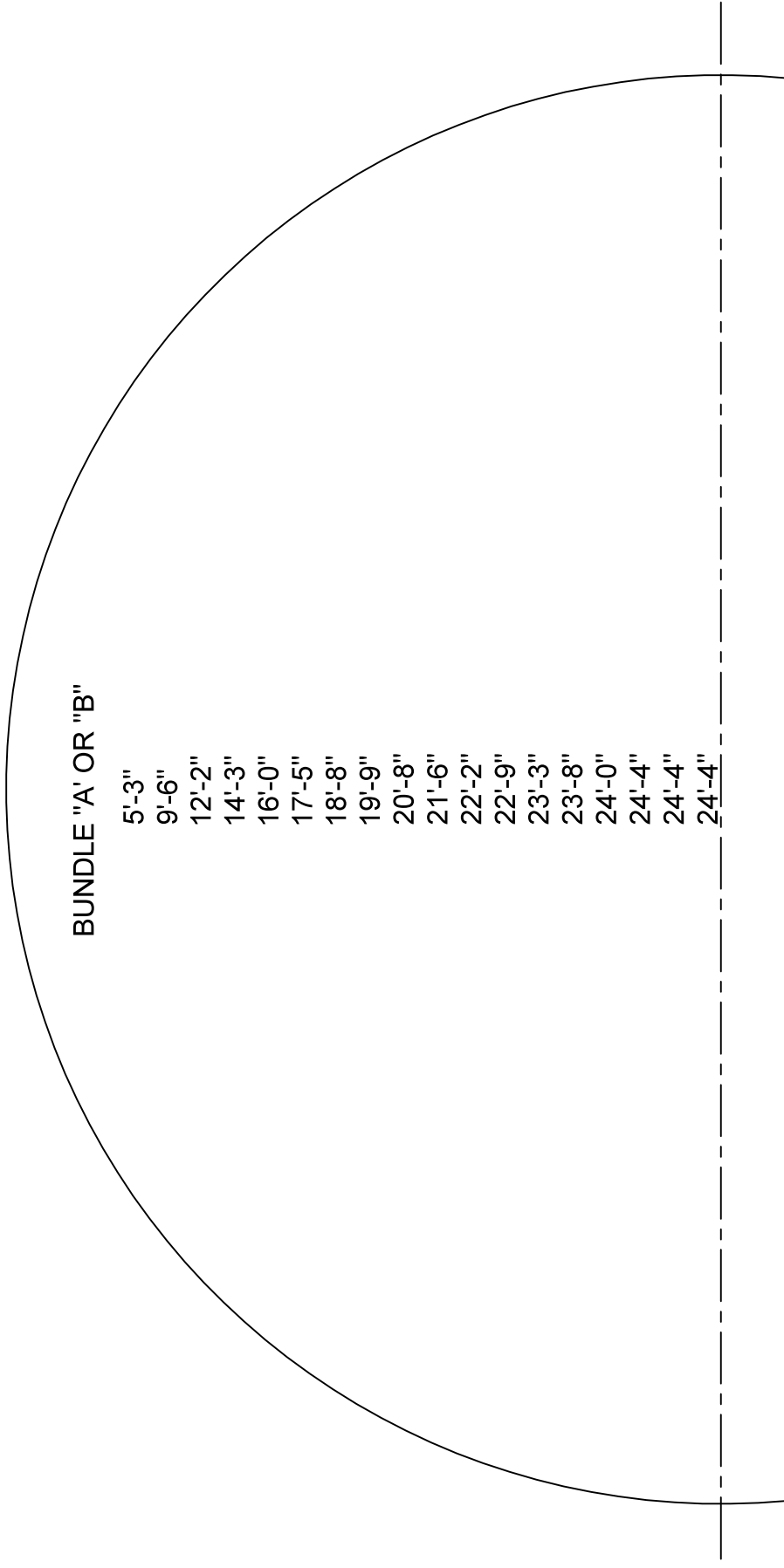

BUNDLE "A" OR "B"

- 5'-3"
- 9'-6"
- 12'-2"
- 14'-3"
- 16'-0"
- 17'-5"
- 18'-8"
- 19'-9"
- 20'-8"
- 21'-6"
- 22'-2"
- 22'-9"
- 23'-3"
- 23'-8"
- 24'-0"
- 24'-4"
- 24'-4"
- 24'-4"

36 Pieces per Bin
688 Feet of Flooring
1154.46 Pounds total
8 Bundles of Flashing
8 Hardware Sacks for Flashing

Bundle "B" is identical
to Bundle "A"

24'-9" FLOOR

OPEN SIDE OF LEGS SHOULD ALWAYS BE IN SAME DIRECTION EXCEPT ON PERIMETER RAILS.

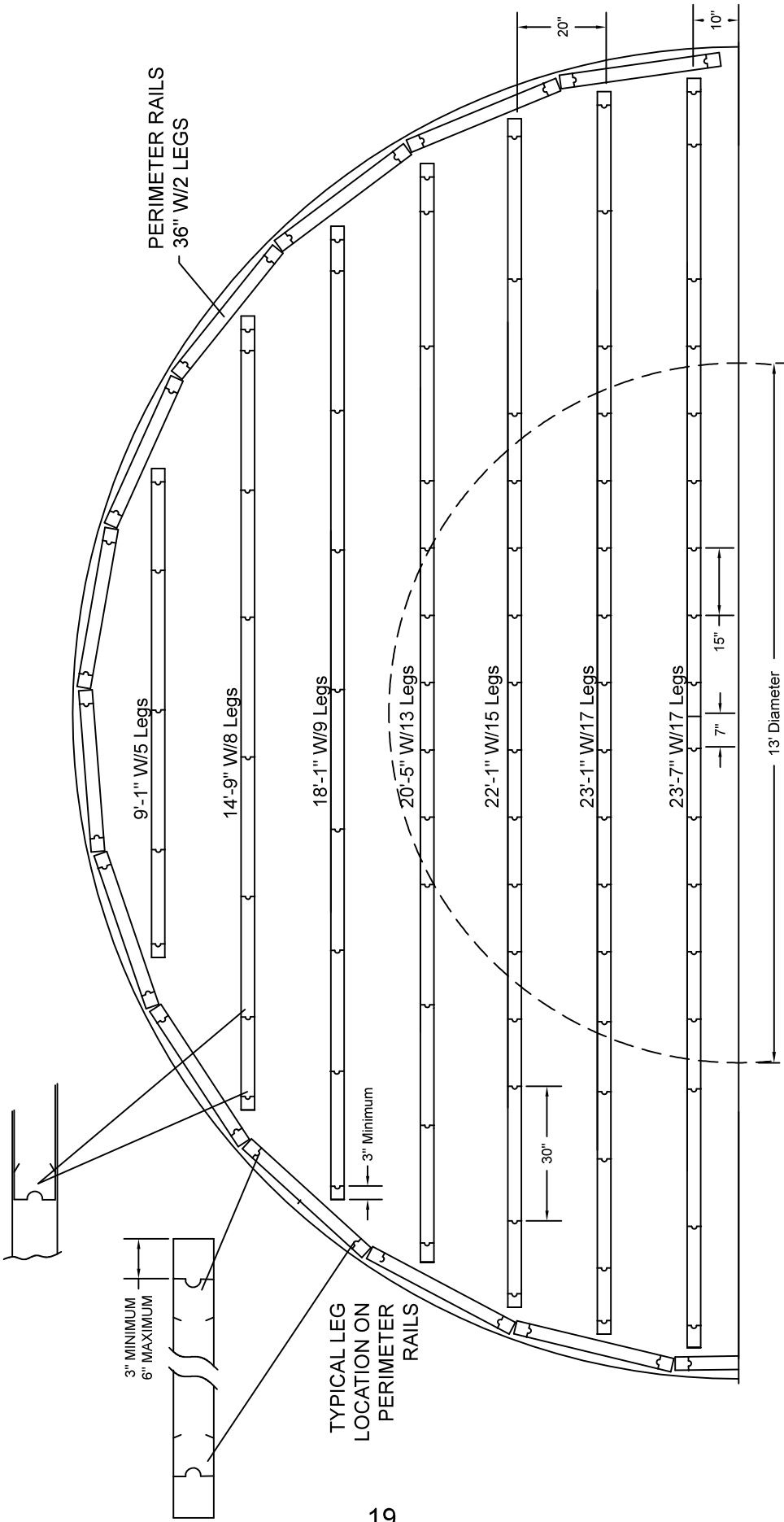

- 19 BUNDLES OF LEGS
- 4 BUNDLES OF PERIMETER RAILS
- 3 BUNDLES OF RAIL TIES AT 20" C-C
- 2 BAGS OF POP RIVETS (100 PCS)

- 15" LEG SPACING INSIDE 13' CIRCLE
- 30" LEG SPACING OUTSIDE 13' CIRCLE.
- LEGS AT 30" SPACING SHOULD BE STAGGERED. (NOT LINED UP FROM RAIL TO RAIL.)

27' FLOOR

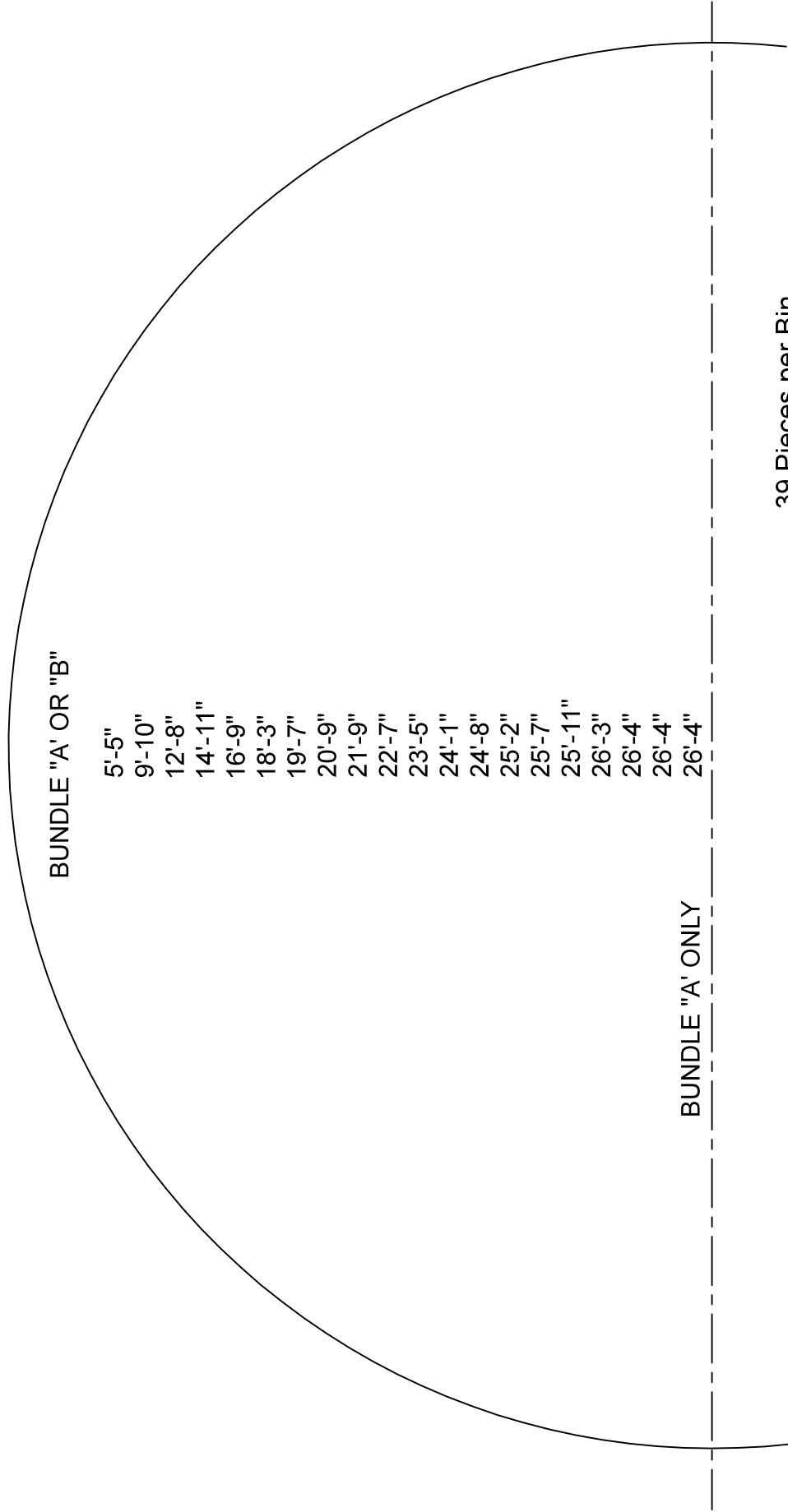

BUNDLE "A" OR "B"

- 5'-5"
- 9'-10"
- 12'-8"
- 14'-11"
- 16'-9"
- 18'-3"
- 19'-7"
- 20'-9"
- 21'-9"
- 22'-7"
- 23'-5"
- 24'-1"
- 24'-8"
- 25'-2"
- 25'-7"
- 25'-11"
- 26'-3"
- 26'-4"
- 26'-4"
- 26'-4"

BUNDLE "A" ONLY

39 Pieces per Bin
806.83 Ft. of Flooring
1353.86 Pounds total
9 Bundles of Flashing
9 Hardware Sacks for Flashing

Bundle "B" is identical
to Bundle "A" with exception
of One Piece of 26'-4" Length.

27' FLOOR

OPEN SIDE OF LEGS SHOULD ALWAYS BE IN SAME DIRECTION EXCEPT ON PERIMETER RAILS.

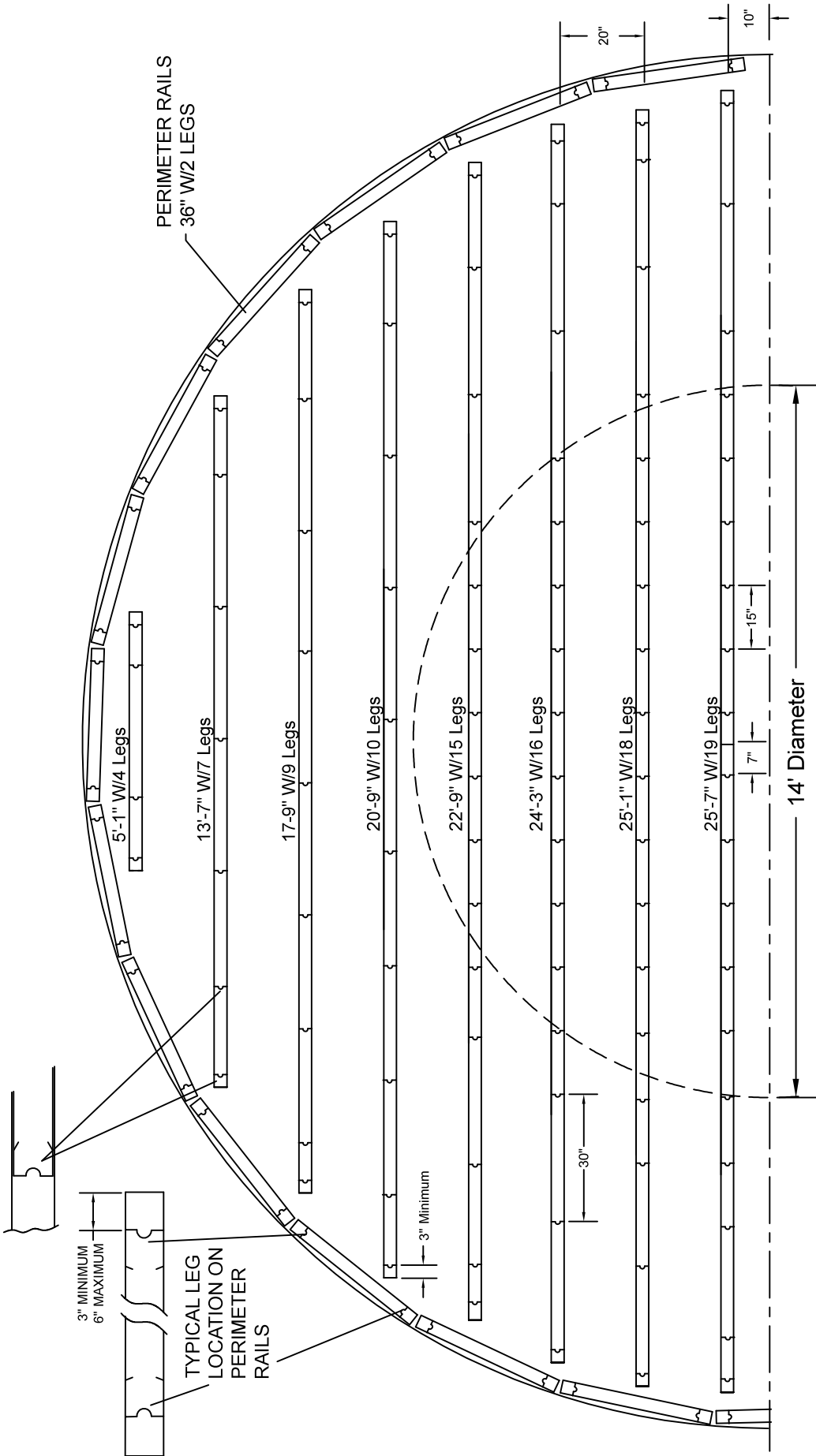

- 22 BUNDLES OF LEGS
- 5 BUNDLES OF PERIMETER RAILS
- 3 BUNDLES OF RAIL TIES AT 20" C-C
- 2 BAGS OF POP RIVETS (100 PCS)

- 15" LEG SPACING INSIDE 14' CIRCLE
- 30" LEG SPACING OUTSIDE 14' CIRCLE.
- LEGS AT 30" SPACING SHOULD BE STAGGERED. (NOT LINED UP FROM RAIL TO RAIL.)

27'-10" FLOOR

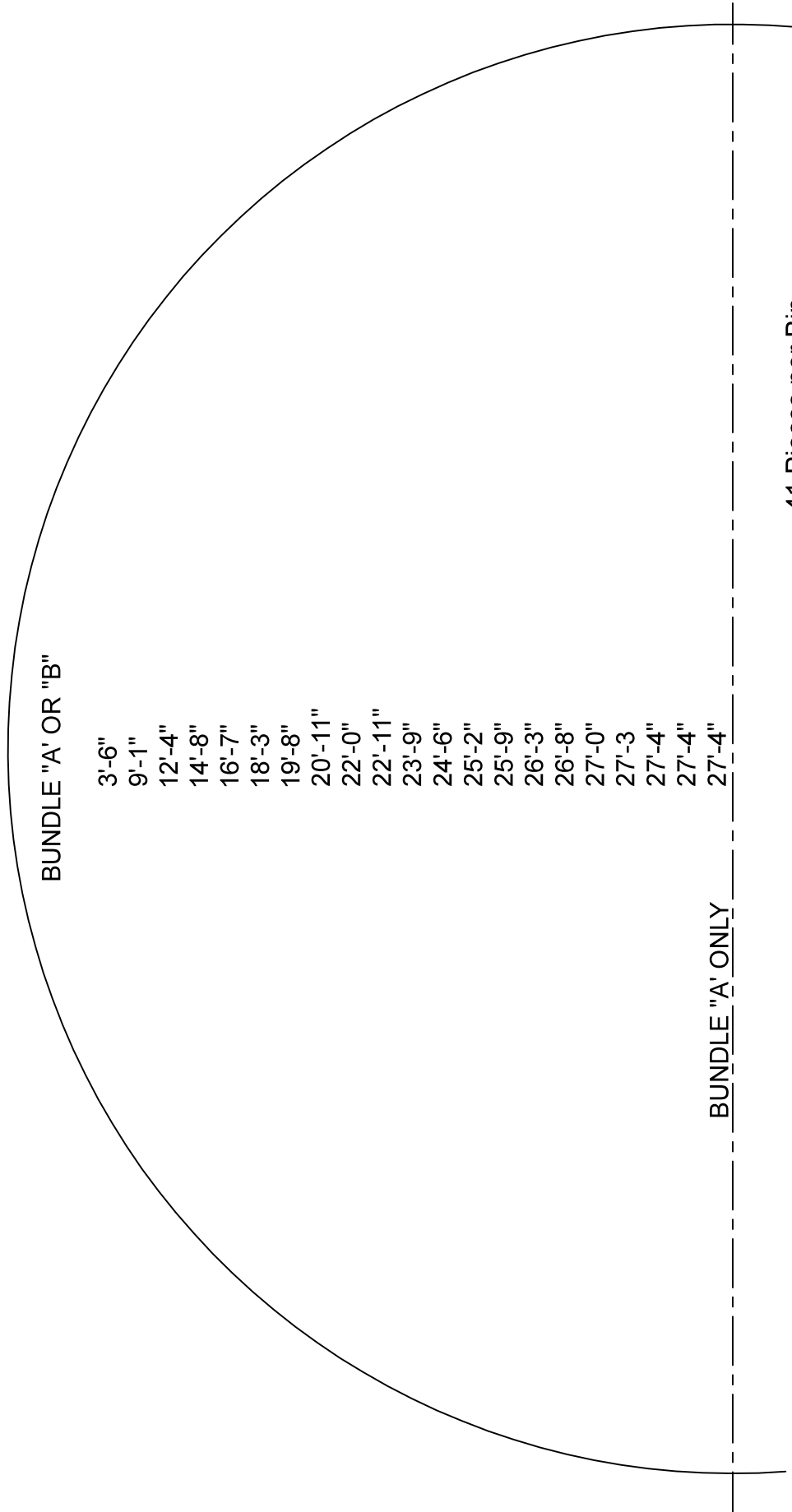

41 Pieces per Bin
 869 Feet of Flooring
 1458.46 Pounds total
 9 Bundles of Flashing
 9 Hardware Sacks for Flashing

Bundle "B" is identical
 to Bundle "A" with exception
 of One Piece of 27'-4" Length.

27'-10" FLOOR

OPEN SIDE OF LEGS SHOULD ALWAYS BE IN SAME DIRECTION EXCEPT ON PERIMETER RAILS.

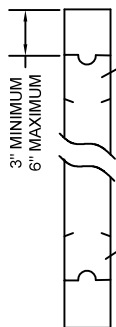
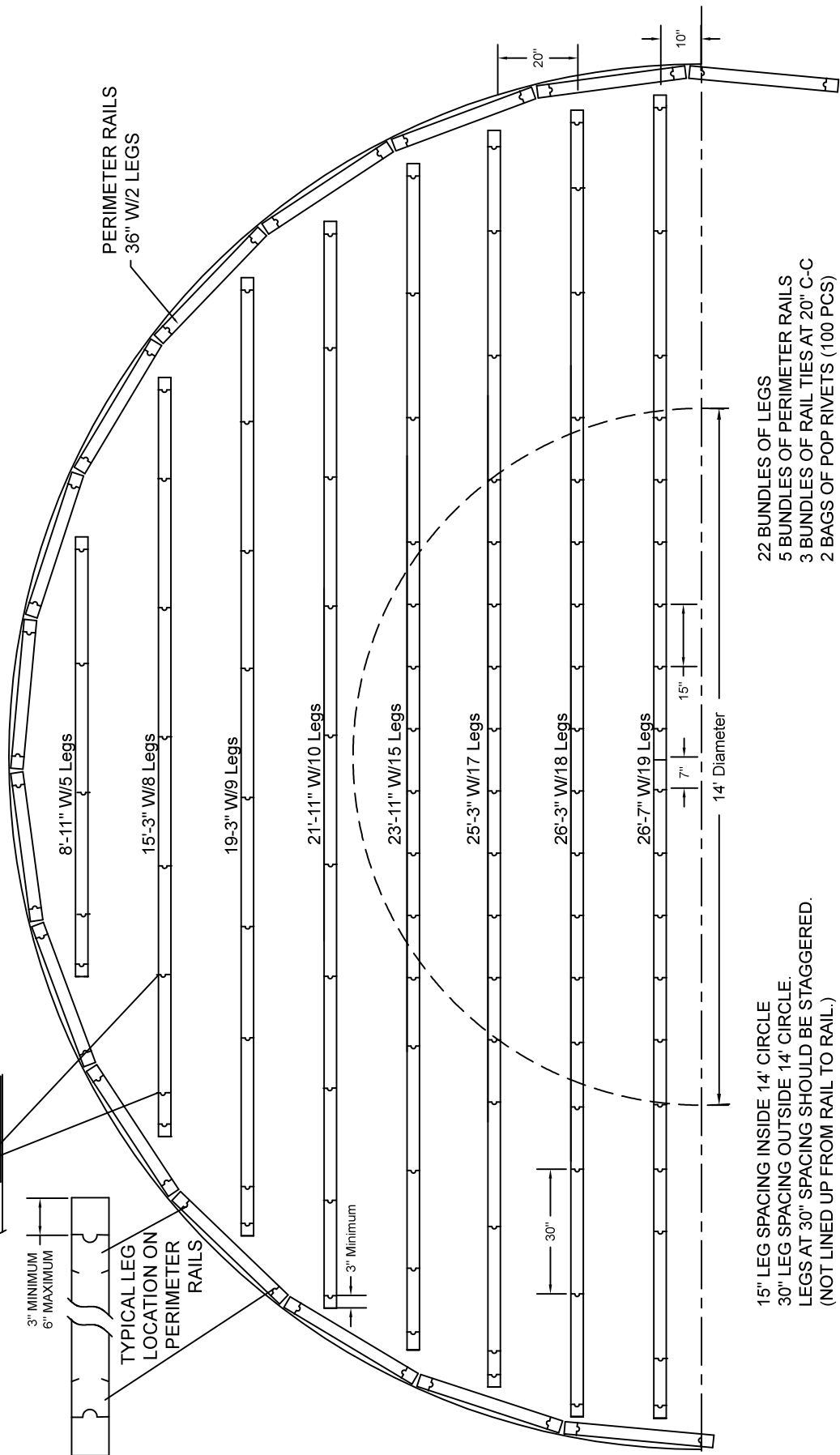

- 22 BUNDLES OF LEGS
- 5 BUNDLES OF PERIMETER RAILS
- 3 BUNDLES OF RAIL TIES AT 20" C-C
- 2 BAGS OF POP RIVETS (100 PCS)

- 15" LEG SPACING INSIDE 14' CIRCLE
- 30" LEG SPACING OUTSIDE 14' CIRCLE.
- LEGS AT 30" SPACING SHOULD BE STAGGERED. (NOT LINED UP FROM RAIL TO RAIL.)

30' FLOOR

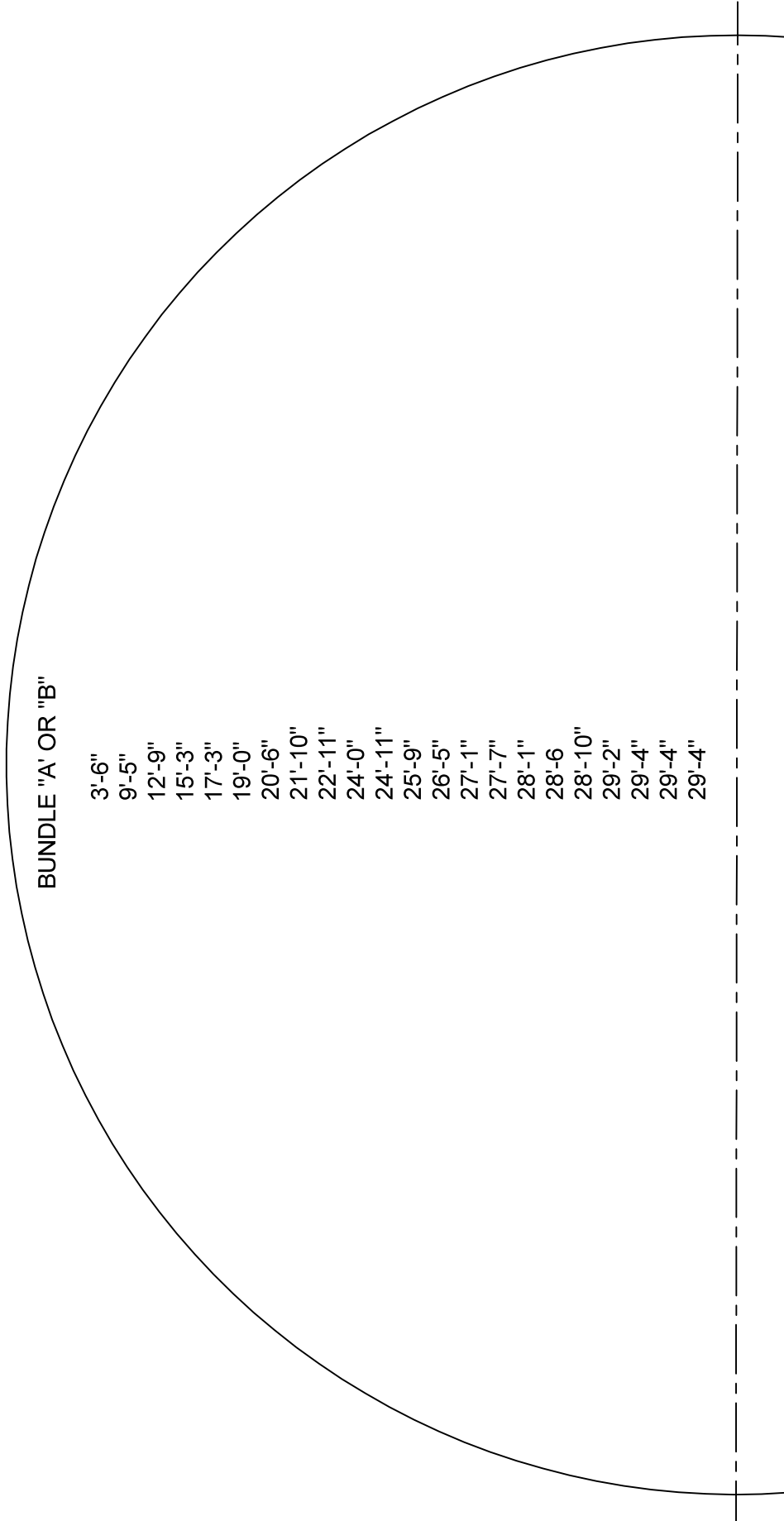

BUNDLE "A" OR "B"

- 3'-6"
- 9'-5"
- 12'-9"
- 15'-3"
- 17'-3"
- 19'-0"
- 20'-6"
- 21'-10"
- 22'-11"
- 24'-0"
- 24'-11"
- 25'-9"
- 26'-5"
- 27'-1"
- 27'-7"
- 28'-1"
- 28'-6"
- 28'-10"
- 29'-2"
- 29'-4"
- 29'-4"
- 29'-4"

44 Pieces per Bin
1001.5 ft. of Flooring
1680.51 Pounds total
10 Bundles of Flashing
10 Hardware Sacks for Flashing

Bundle "B" is identical
to Bundle "A"

30' FLOOR

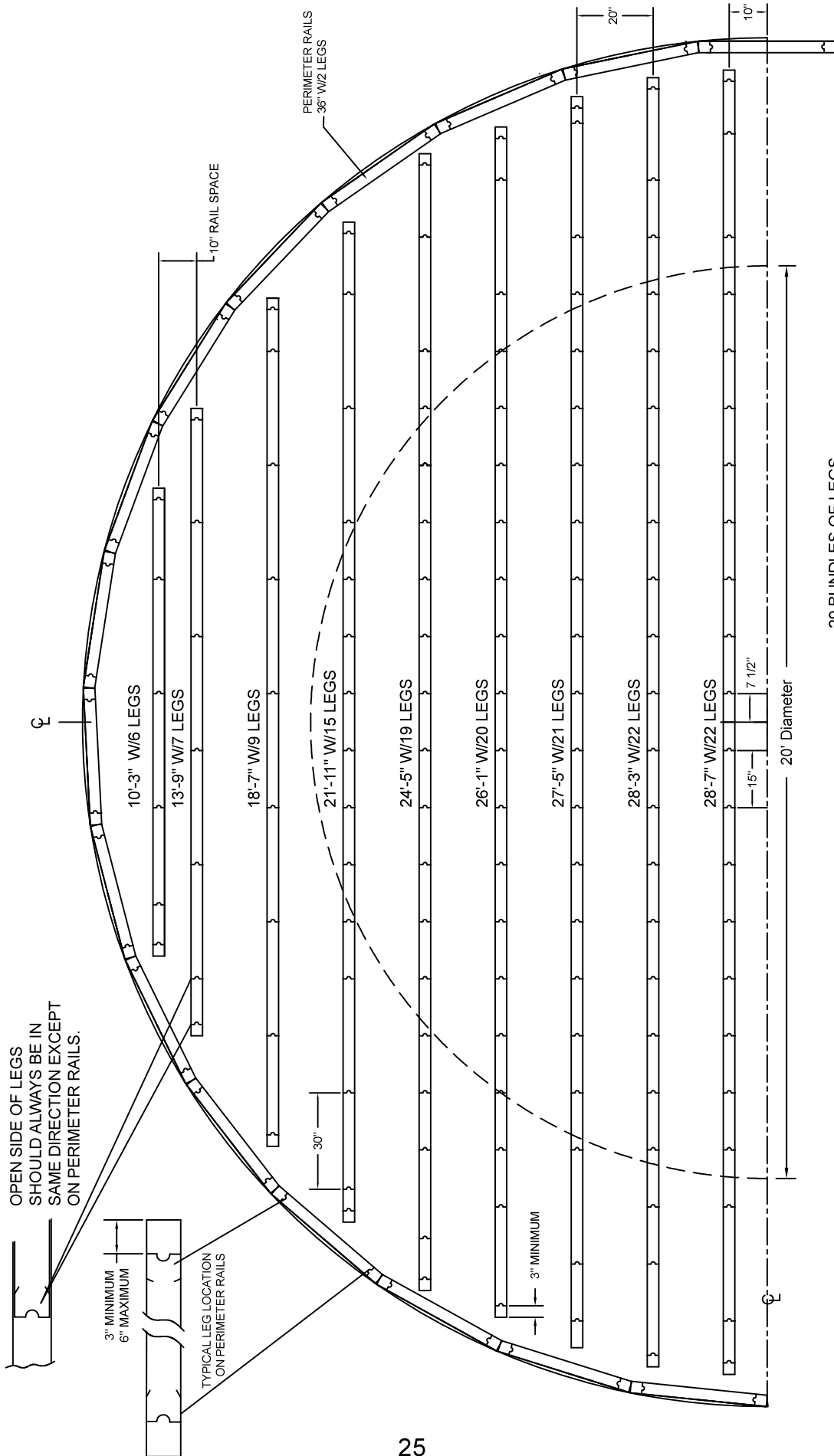

- 29 BUNDLES OF LEGS
- 5 BUNDLES OF PERIMETER RAILS
- 4 BUNDLES OF RAIL TIES AT 20" C-C
- 1 BUNDLE OF RAIL TIES AT 10" C-C
- 2 BAGS OF POP RIVETS (100 PCS)

15" LEG SPACING INSIDE 20' CIRCLE
 30" LEG SPACING OUTSIDE 20' CIRCLE.
 LEGS AT 30" SPACING SHOULD BE STAGGERED.
 (NOT LINED UP FROM RAIL TO RAIL.)

31' FLOOR

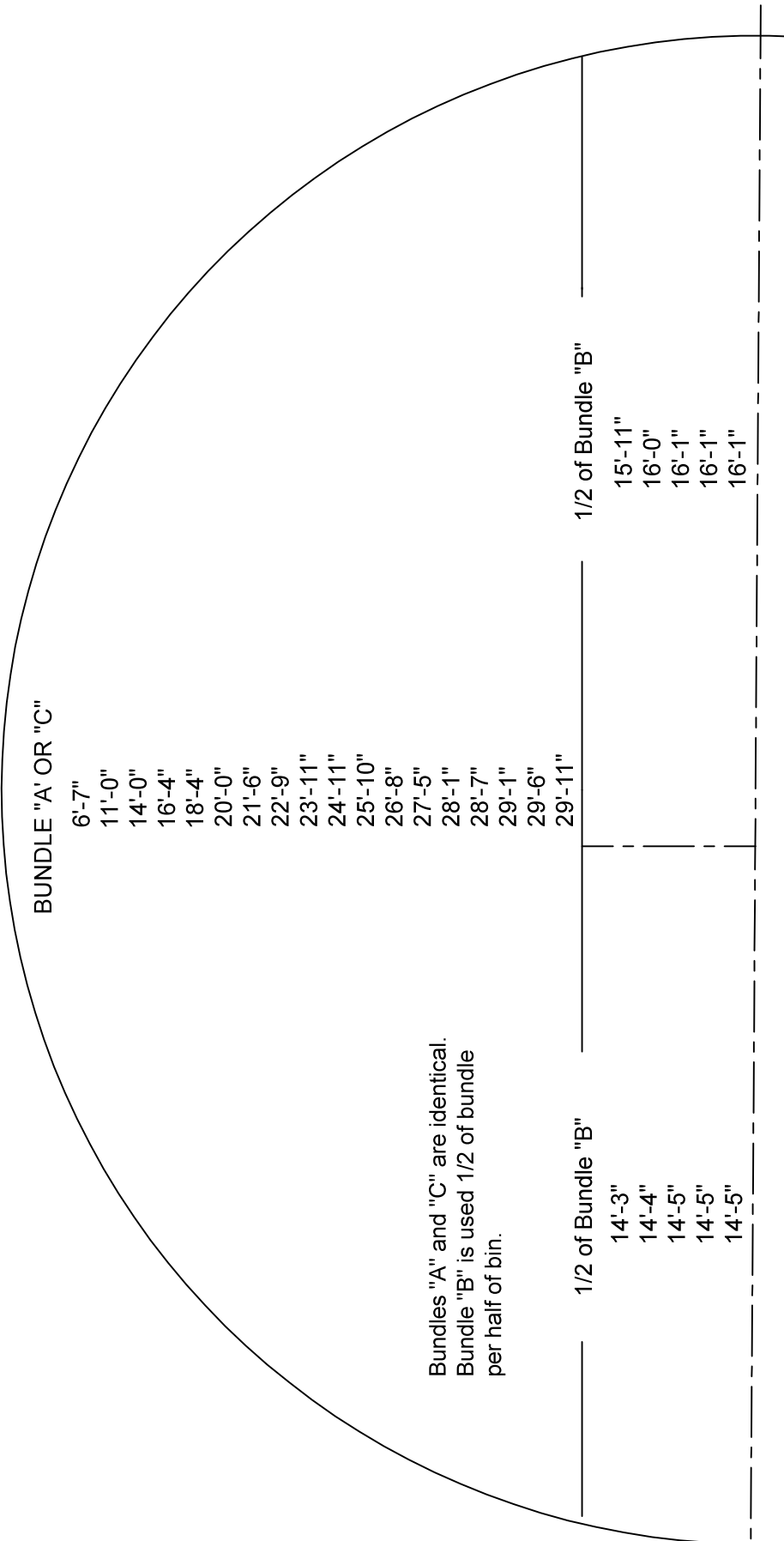

Bundles "A" and "C" are identical.
 Bundle "B" is used 1/2 of bundle
 per half of bin.

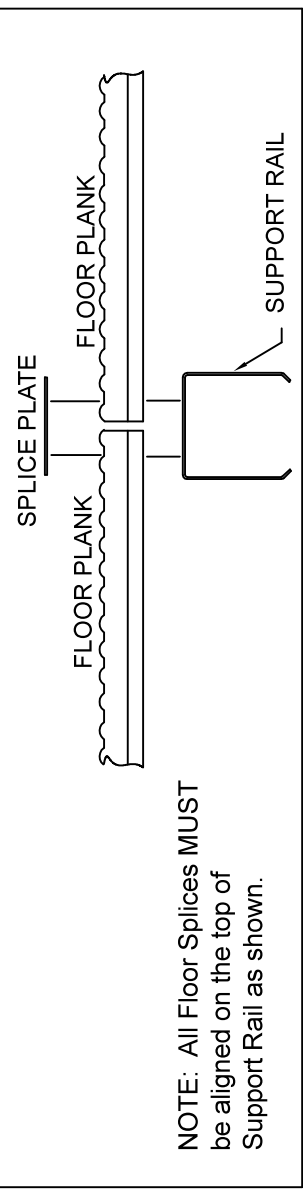

- 45 Pieces per Bin
- 1082 Feet of Flooring
- 1816.15 Pounds total
- 10 Bundles of Flashing
- 10 Hardware Sacks for Flashing
- 1 Bundle of Splice Plates
- 1 Hardware Sack for Splice Plates

31' FLOOR

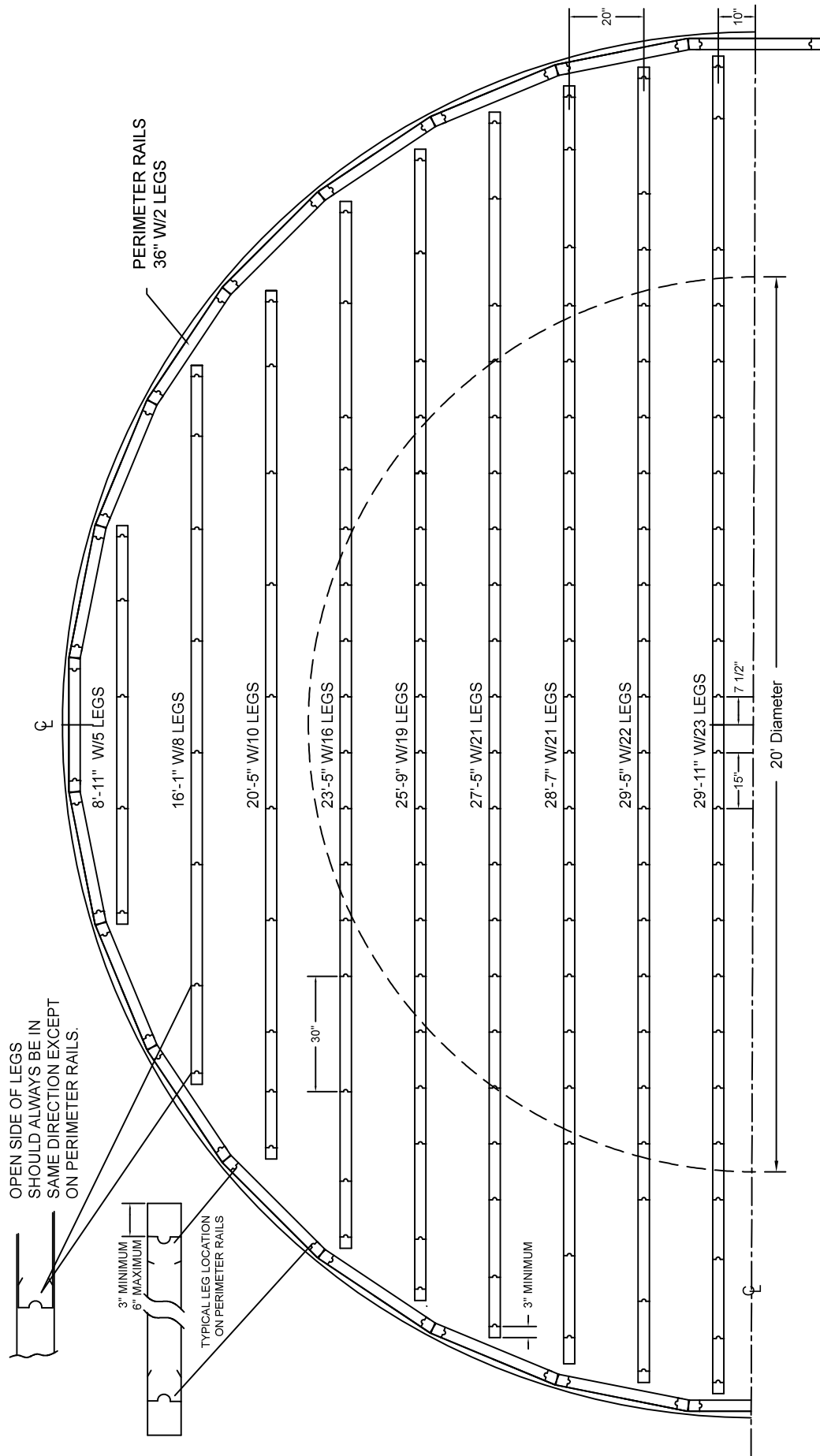

- 30 BUNDLES OF LEGS
- 6 BUNDLES OF PERIMETER RAILS
- 4 BUNDLES OF RAIL TIES AT 20" C-C
- 2 BAGS OF POP RIVETS (100 PCS)

- 15" LEG SPACING INSIDE 20" CIRCLE
- 30" LEG SPACING OUTSIDE 20" CIRCLE
- LEGS AT 30" SPACING SHOULD BE STAGGERED. (NOT LINED UP FROM RAIL TO RAIL.)

33' FLOOR

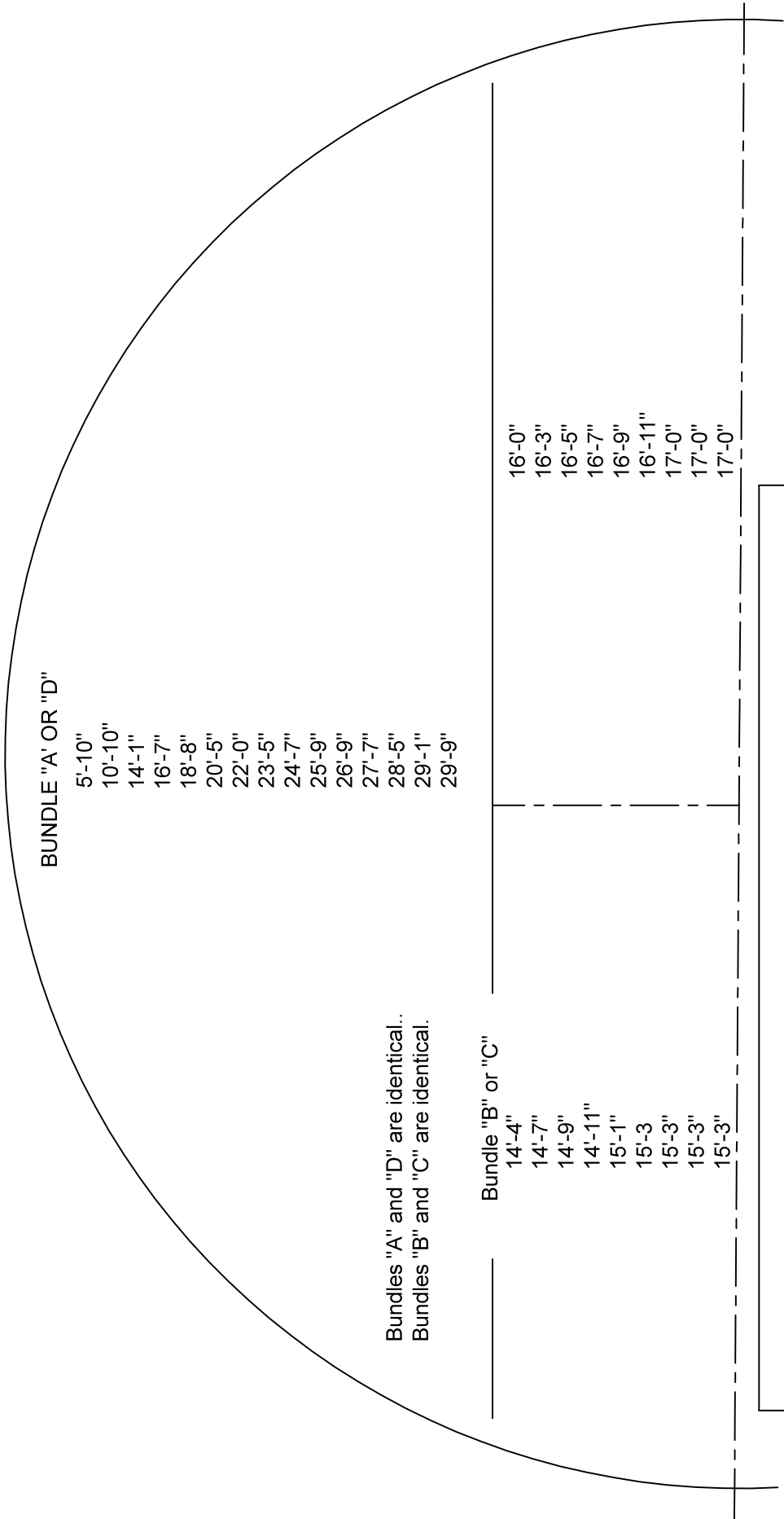

BUNDLE "A" OR "D"

- 5'-10"
- 10'-10"
- 14'-1"
- 16'-7"
- 18'-8"
- 20'-5"
- 22'-0"
- 23'-5"
- 24'-7"
- 25'-9"
- 26'-9"
- 27'-7"
- 28'-5"
- 29'-1"
- 29'-9"

Bundles "A" and "D" are identical.
 Bundles "B" and "C" are identical.

Bundle "B" or "C"

- 14'-4"
- 14'-7"
- 14'-9"
- 14'-11"
- 15'-1"
- 15'-3"
- 15'-3"
- 15'-3"
- 15'-3"

- 16'-0"
- 16'-3"
- 16'-5"
- 16'-7"
- 16'-9"
- 16'-11"
- 17'-0"
- 17'-0"
- 17'-0"

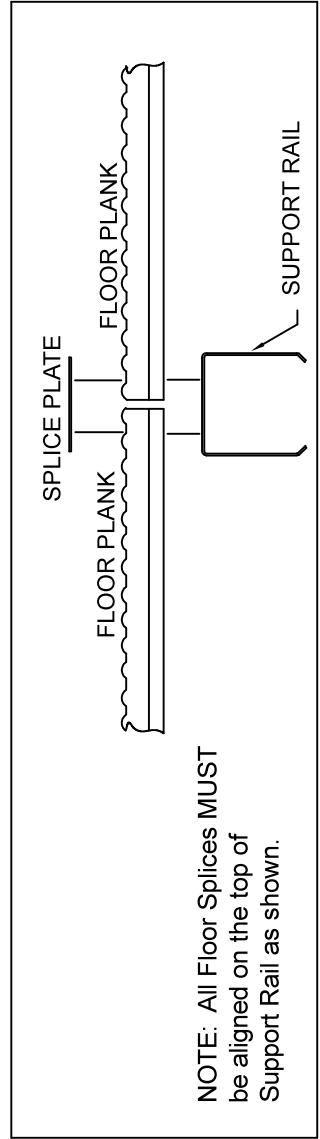

- 48 Pieces per Bin
- 1216.66 ft. of Flooring
- 2041.56 Pounds total
- 11 Bundles of Flashing
- 11 Hardware Sacks for Flashing
- 1 Bundle of Splice Plates
- 1 Hardware Sack for Splice Plates

33' FLOOR

OPEN SIDE OF LEGS SHOULD ALWAYS BE IN SAME DIRECTION EXCEPT ON PERIMETER RAILS.

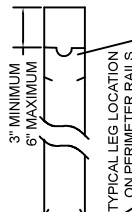
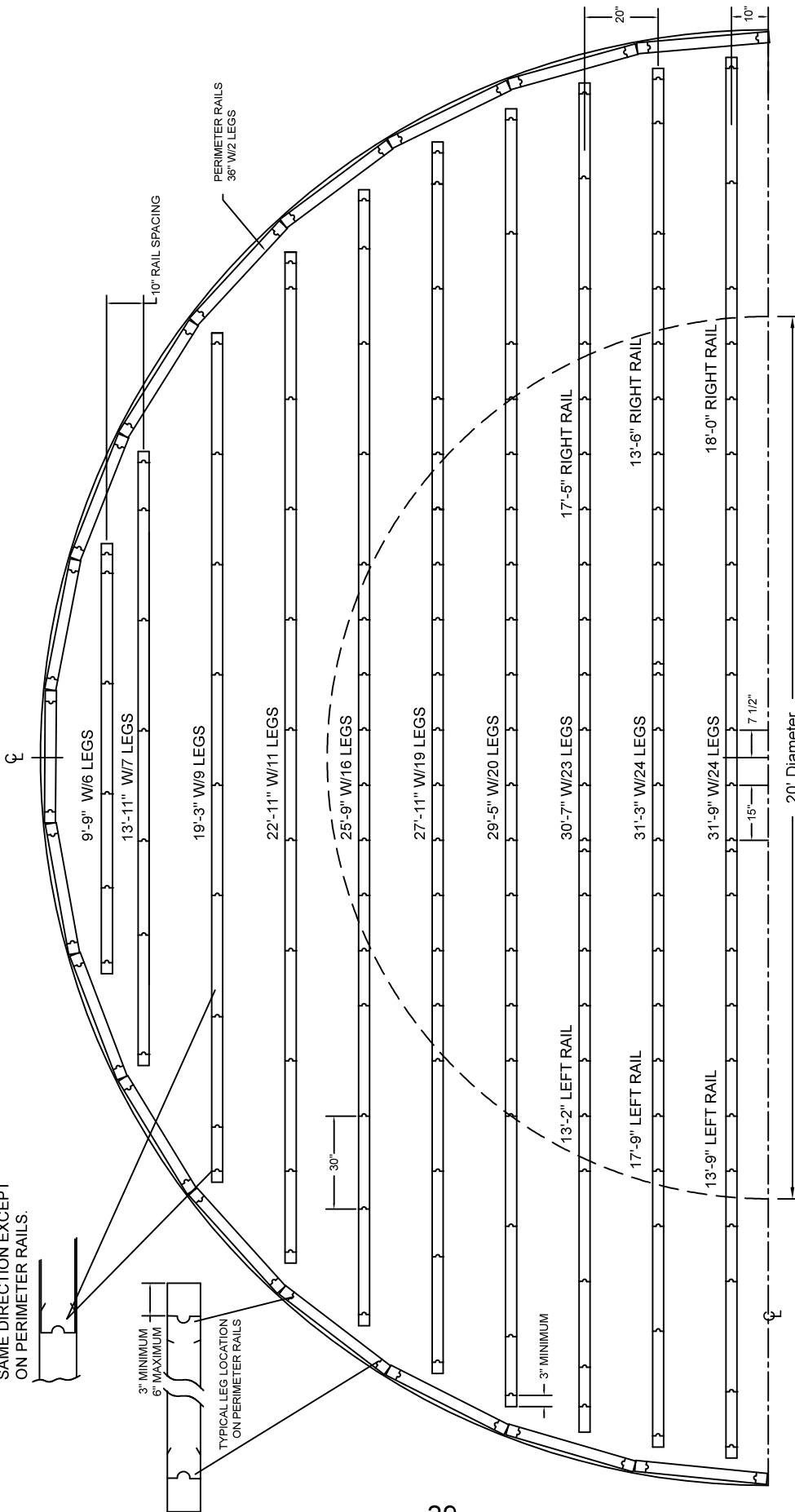

- 33 BUNDLES OF LEGS
- 2 BUNDLES OF RAIL SPLICES
- 6 BUNDLES OF PERIMETER RAILS
- 4 BUNDLES OF RAIL TIES AT 20" C-C
- 1 BUNDLE OF RAIL TIES AT 10" C-C
- 4 BAGS OF POP RIVETS (200 PCS)

- 15" LEG SPACING INSIDE 20' CIRCLE
- 30" LEG SPACING OUTSIDE 20' CIRCLE.
- LEGS AT 30" SPACING SHOULD BE STAGGERED.
- (NOT LINED UP FROM RAIL TO RAIL.)

36' FLOOR

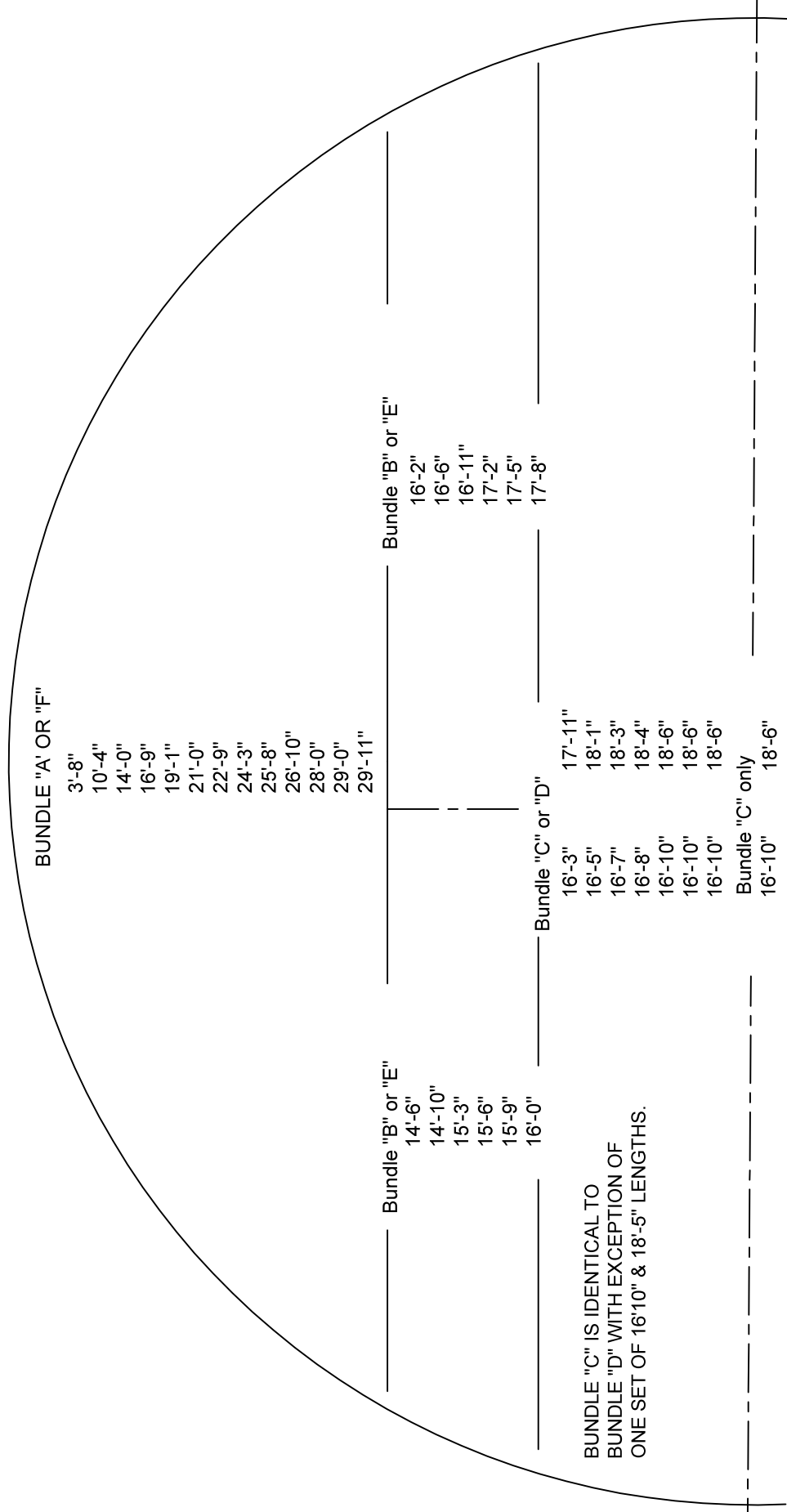

- 53 Pieces per Bin
- 1454.16 ft. of Flooring
- 2440.09 Pounds total
- 12 Bundles of Flashing
- 12 Hardware Sacks for Flashing
- 2 Bundles of Splice Plates
- 2 Hardware Sacks for Splice Plates

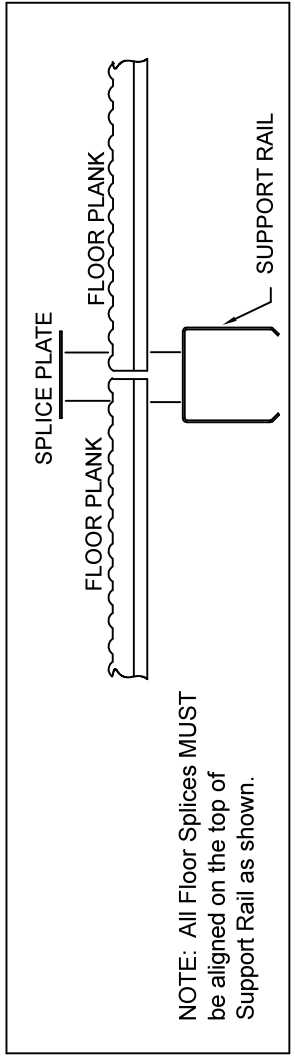

36' FLOOR

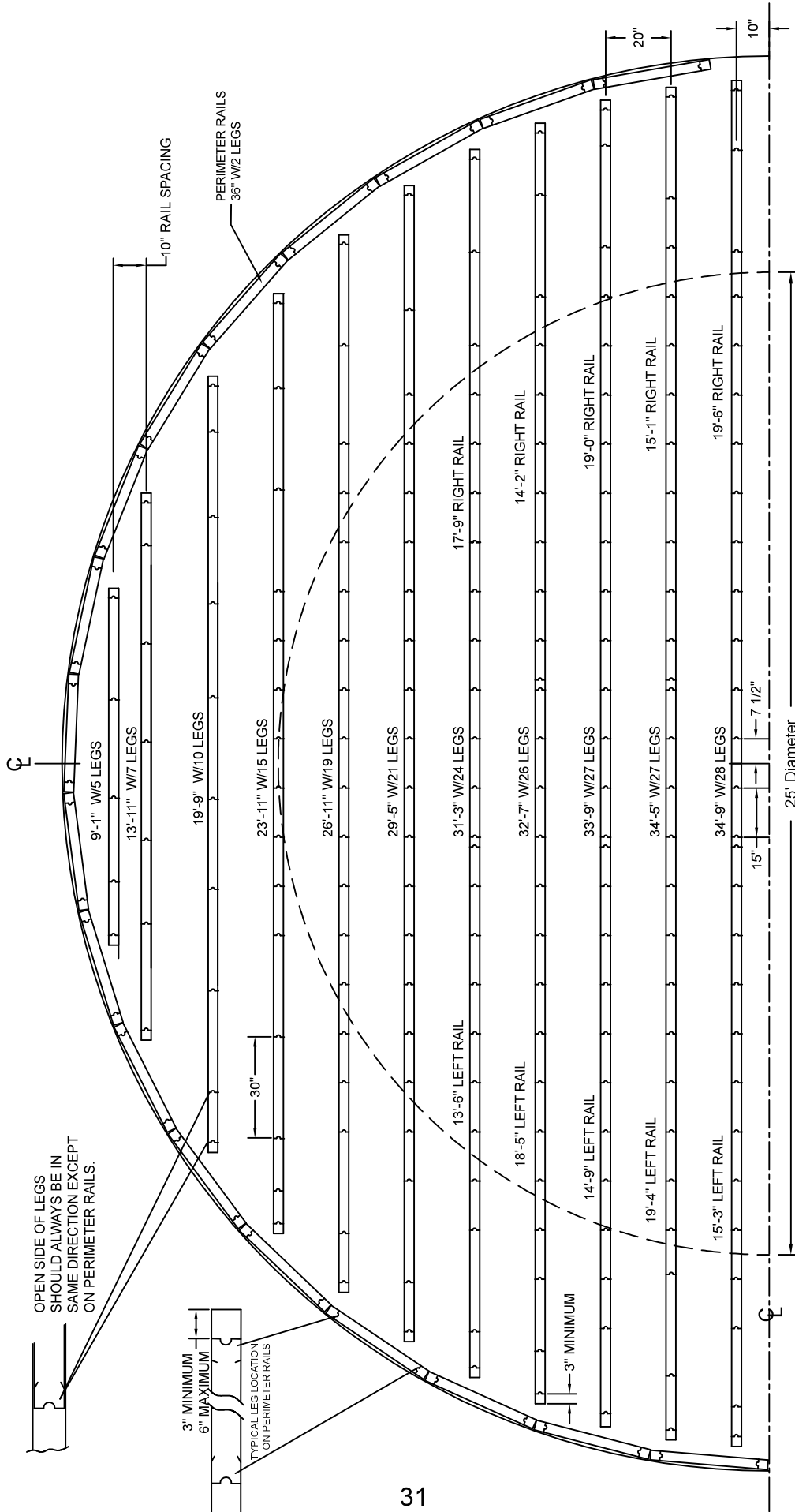

- 42 BUNDLES OF LEGS
- 2 BUNDLES OF RAIL SPLICES
- 7 BUNDLES OF PERIMETER RAILS
- 5 BUNDLES OF RAILS TIES AT 20" C-C
- 1 BUNDLE OF RAILS TIES AT 10" C-C
- 5 BAGS OF POP RIVETS (250 PCS)

- 15" LEG SPACING INSIDE 25' CIRCLE
- 30" LEG SPACING OUTSIDE 25' CIRCLE.
- LEGS AT 30" SPACING SHOULD BE STAGGERED. (NOT LINED UP FROM RAIL TO RAIL.)

42' FLOOR

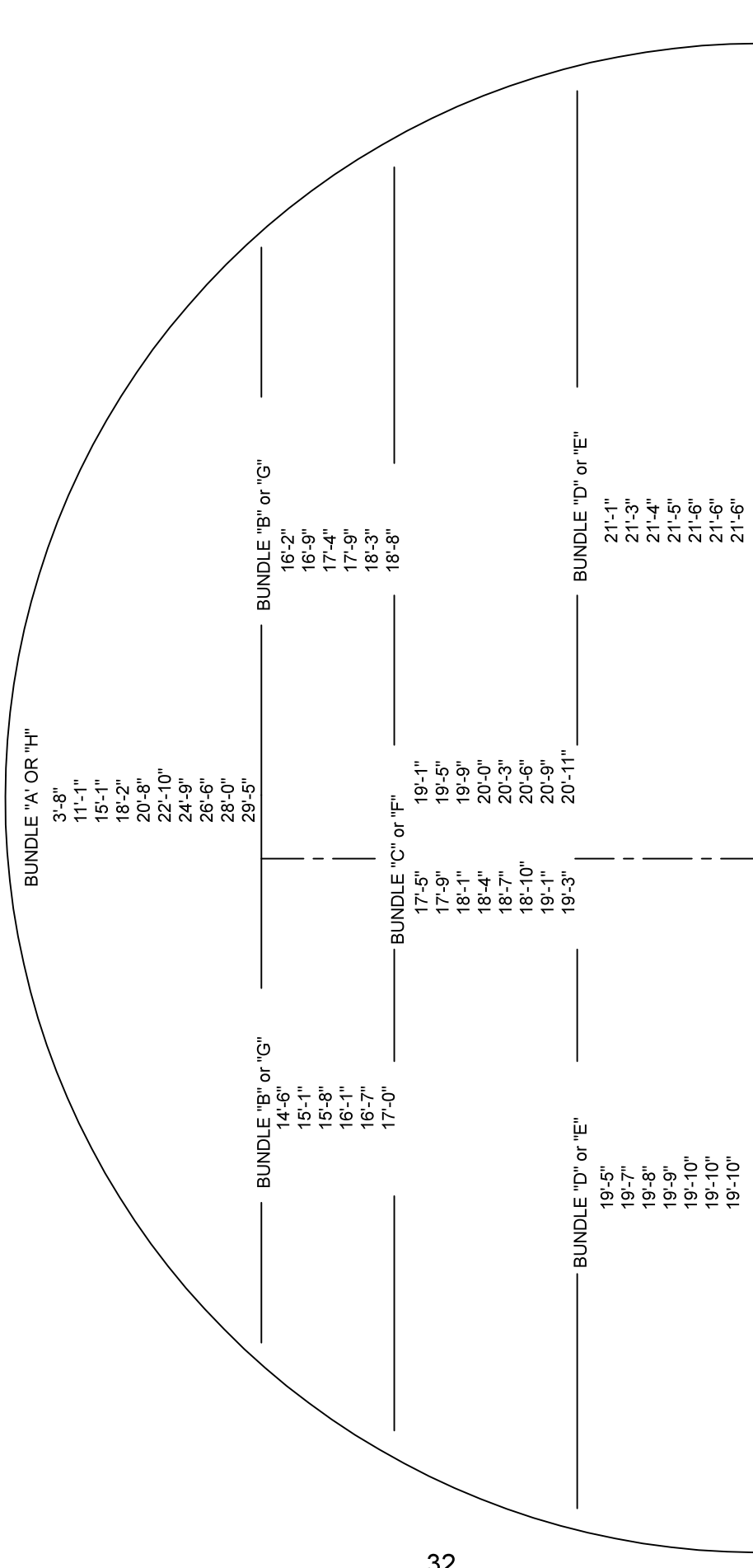

BUNDLES "A" AND "H" ARE IDENTICAL.
 BUNDLES "B" AND "G" ARE IDENTICAL.
 BUNDLES "C" AND "F" ARE IDENTICAL.
 BUNDLES "D" AND "E" ARE IDENTICAL.

- 62 Pieces per Bin
- 1991 Feet of Flooring
- 3340.89 Pounds total
- 14 Bundles of Flashing
- 14 Hardware Sacks for Flashing
- 2 Bundles of Splice Plates
- 2 Hardware Sacks for Splice Plates

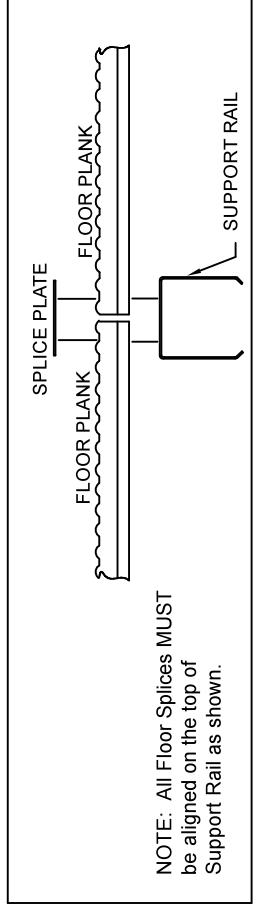

42' FLOOR

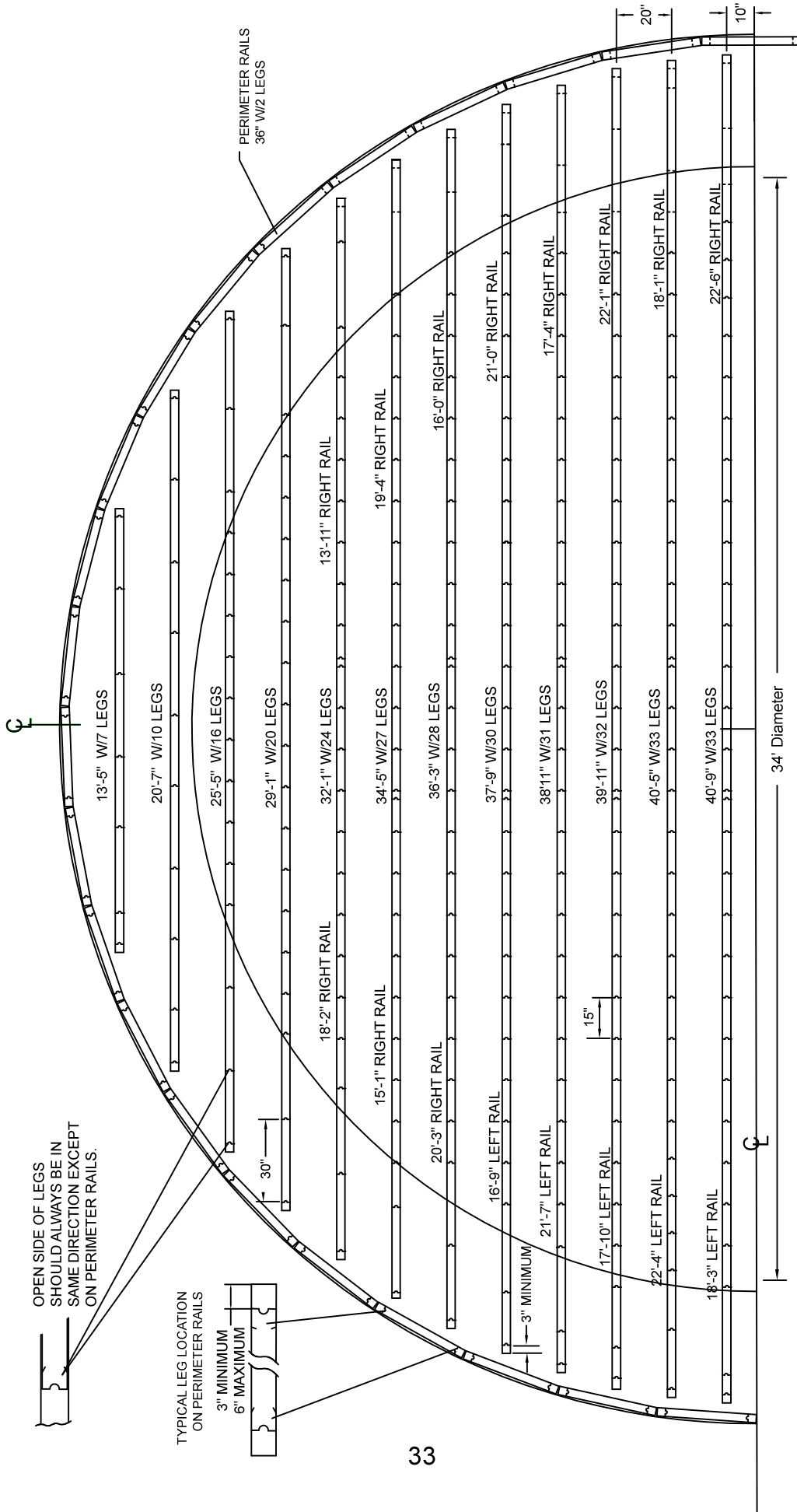

OPEN SIDE OF LEGS
SHOULD ALWAYS BE IN
SAME DIRECTION EXCEPT
ON PERIMETER RAILS.

TYPICAL LEG LOCATION
ON PERIMETER RAILS



15" LEG SPACING INSIDE 34' CIRCLE
30" LEG SPACING OUTSIDE 34' CIRCLE.
LEGS AT 30" SPACING SHOULD BE STAGGERED.
(NOT LINED UP FROM RAIL TO RAIL.)

57 BUNDLES OF LEGS
7 BUNDLES OF PERIMETER RAILS
7 BUNDLES OF RAIL TIES AT 20" C-C
4 BUNDLES OF RAIL SPLICES
6 BAGS OF POP RIVETS (300 PCS)

48' FLOOR

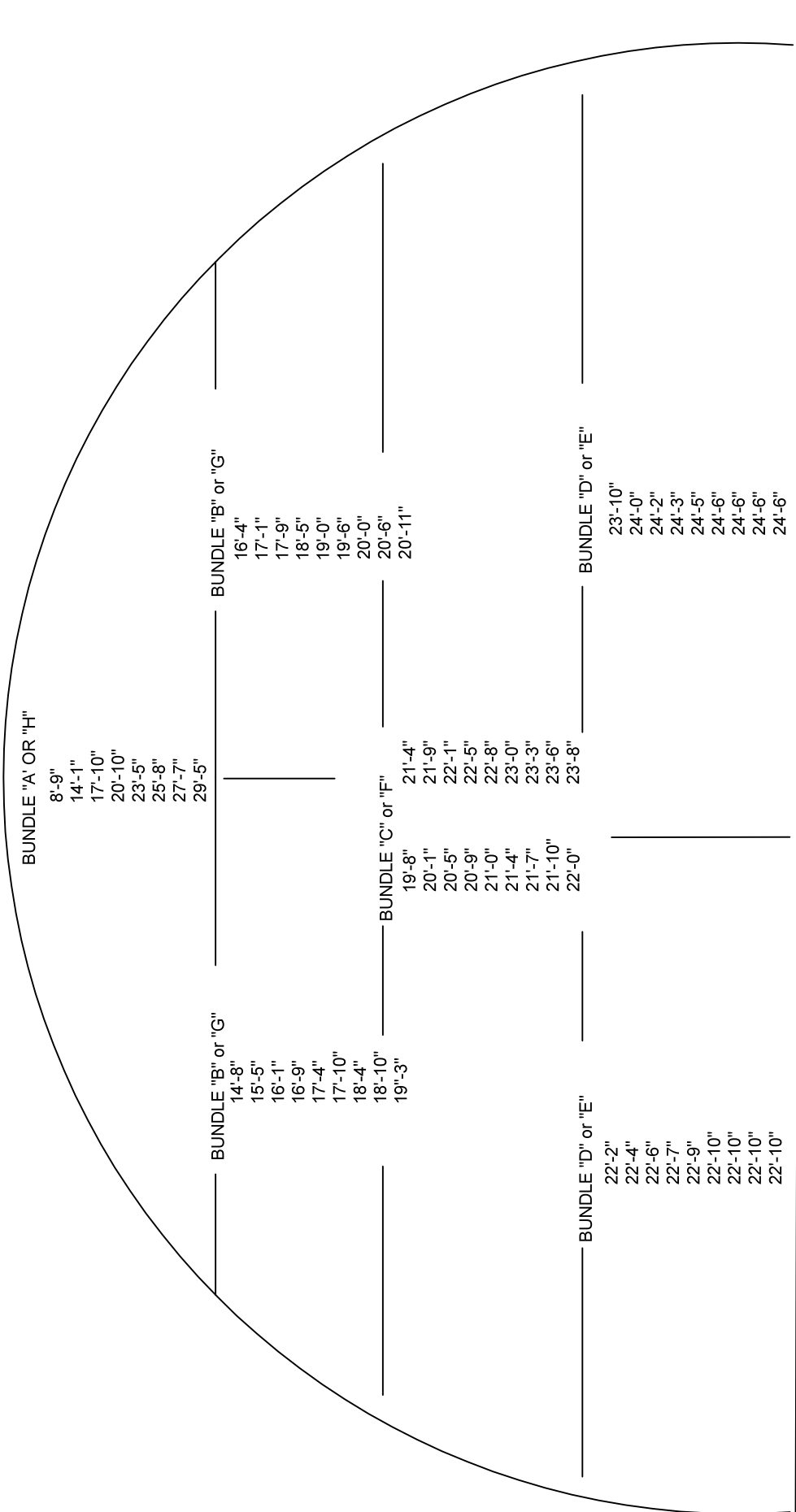

BUNDLES "A" AND "H" ARE IDENTICAL.
 BUNDLES "B" AND "G" ARE IDENTICAL.
 BUNDLES "C" AND "F" ARE IDENTICAL.
 BUNDLES "D" AND "E" ARE IDENTICAL.

- 70 Pieces per Bin
- 2612 Feet of Flooring
- 4383.77 Pounds total
- 16 Bundles of Flashing
- 16 Hardware Sacks for Flashing
- 2 Bundles of Splice Plates
- 2 Hardware Sacks for Splice Plates

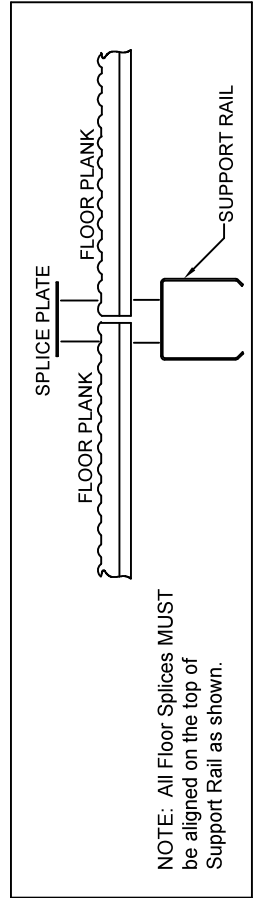

48' FLOOR

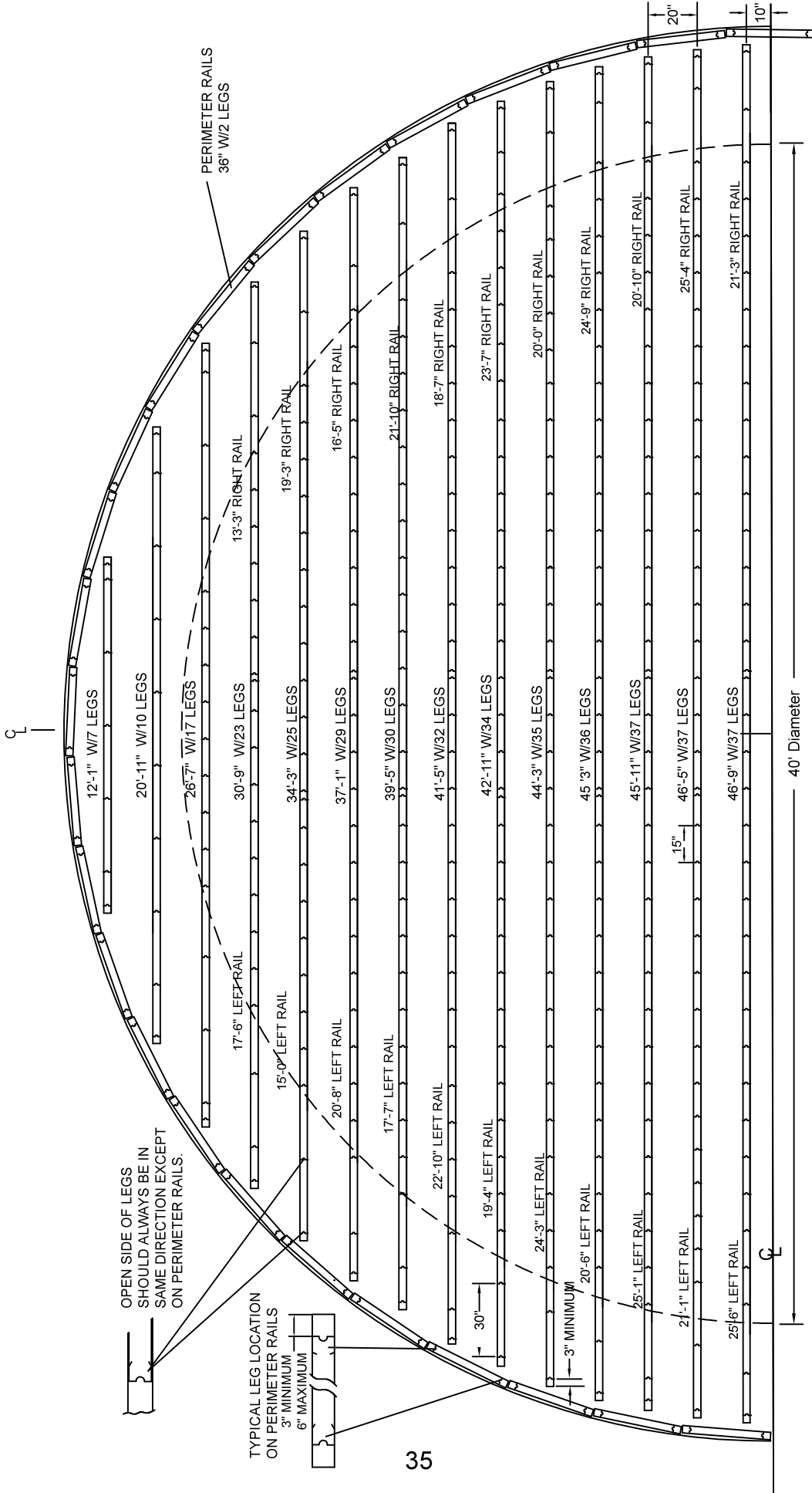

35

- 73 BUNDLES OF LEGS
- 8 BUNDLES OF PERIMETER RAILS
- 10 BUNDLES OF RAIL TIES AT 20" C-C
- 5 BUNDLES OF RAIL SPLICES
- 8 BAGS OF POP RIVETS (400 PCS)

15" LEG SPACING INSIDE 40' CIRCLE
30" LEG SPACING OUTSIDE 40' CIRCLE.
LEGS AT 30" SPACING SHOULD BE STAGGERED.
(NOT LINED UP FROM RAIL TO RAIL.)

48' FLOOR W/ 20-1/4" TALL LEGS

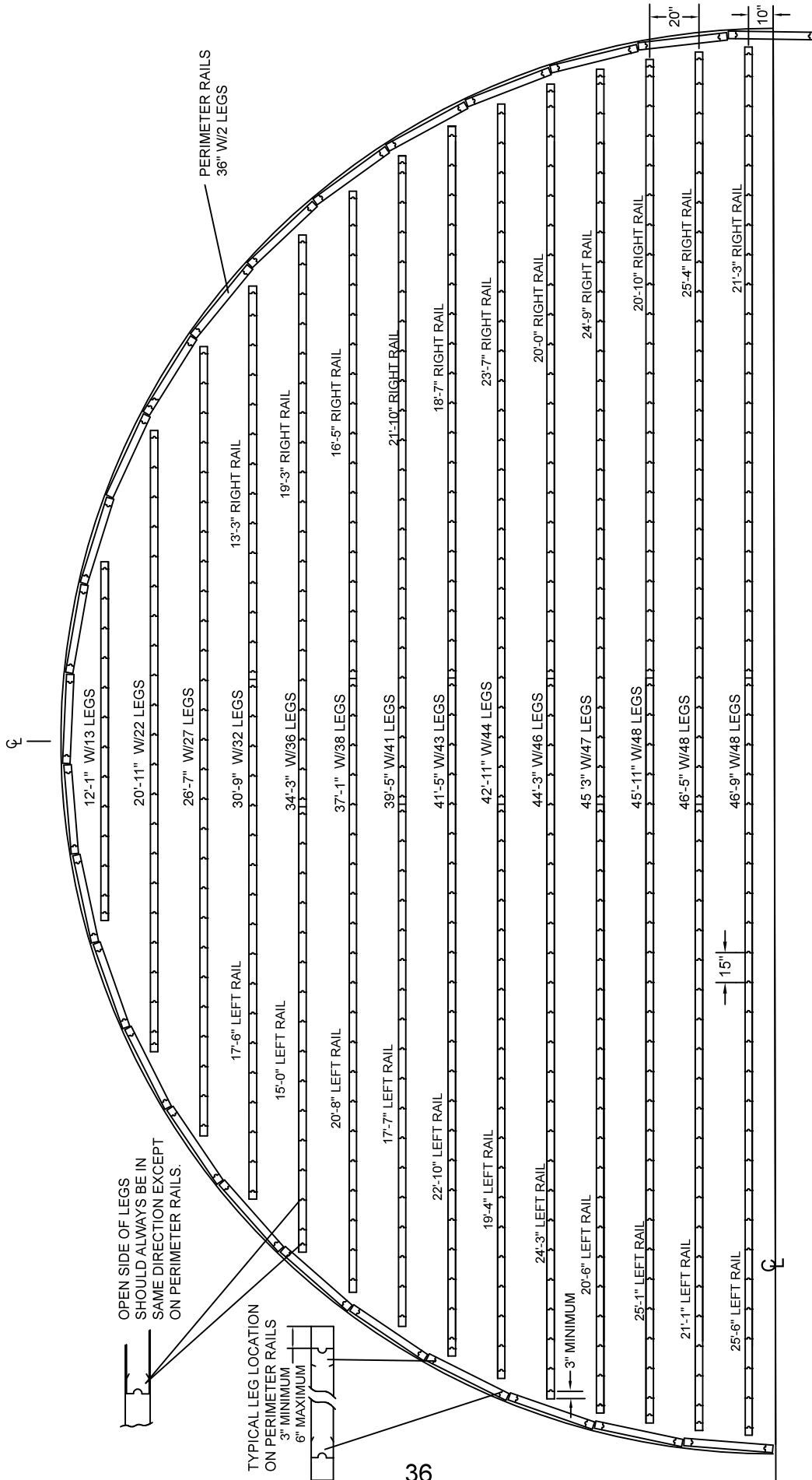

- 12" LEG SPACING
- 100 BUNDLES OF LEGS
- 8 BUNDLES OF PERIMETER RAILS
- 10 BUNDLES OF RAIL TIES AT 20" C-C
- 5 BUNDLES OF RAIL SPLICES
- 8 BAGS OF POP RIVETS (400 PCS)

48' FLOOR FOR DF2500 W/ 20-1/4" TALL LEGS

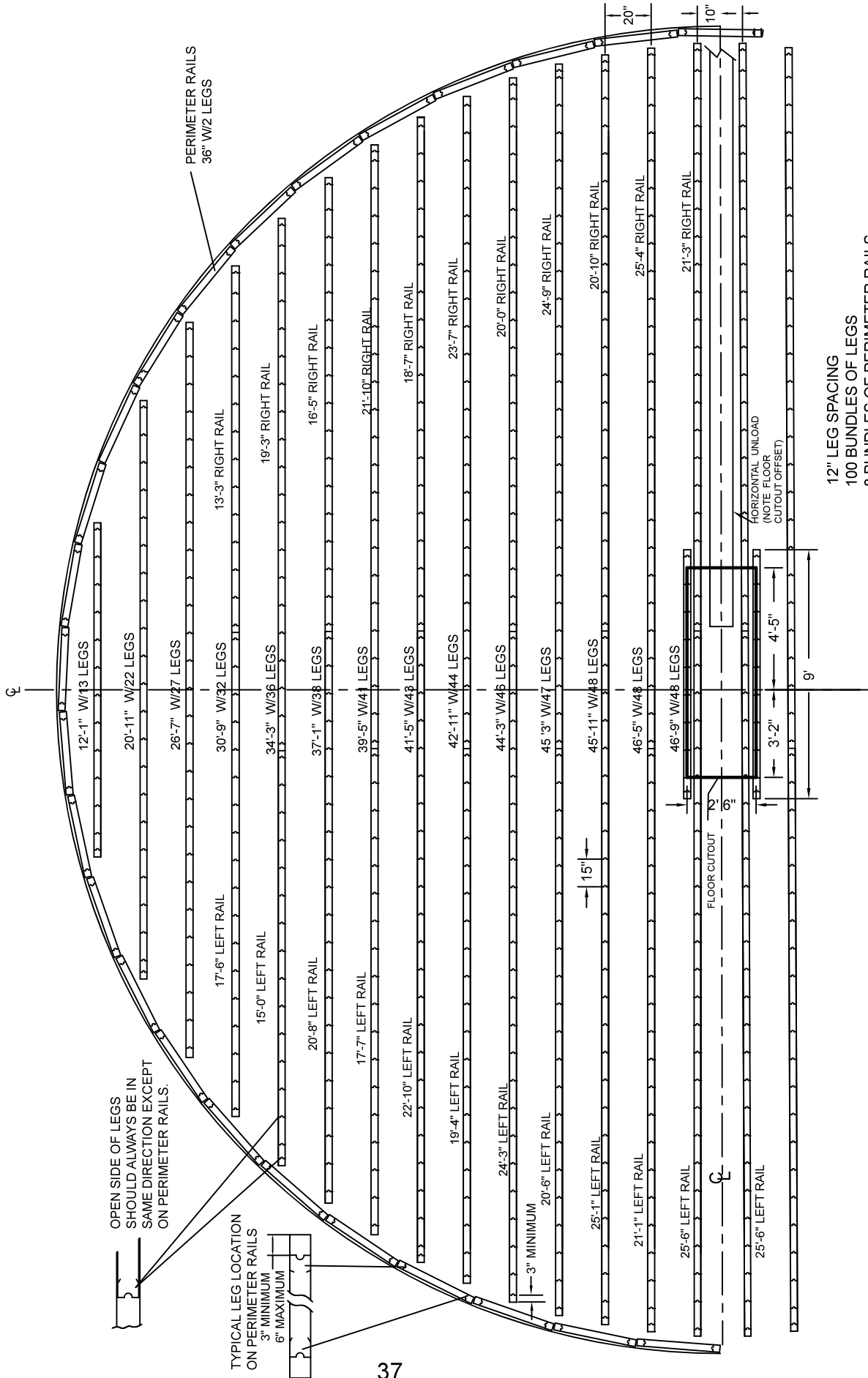

48' FLOOR FOR DF2500 W/ 20-1/4" TALL LEGS

DETAIL OF FLOOR CUTOUT AND RAIL PLACEMENT

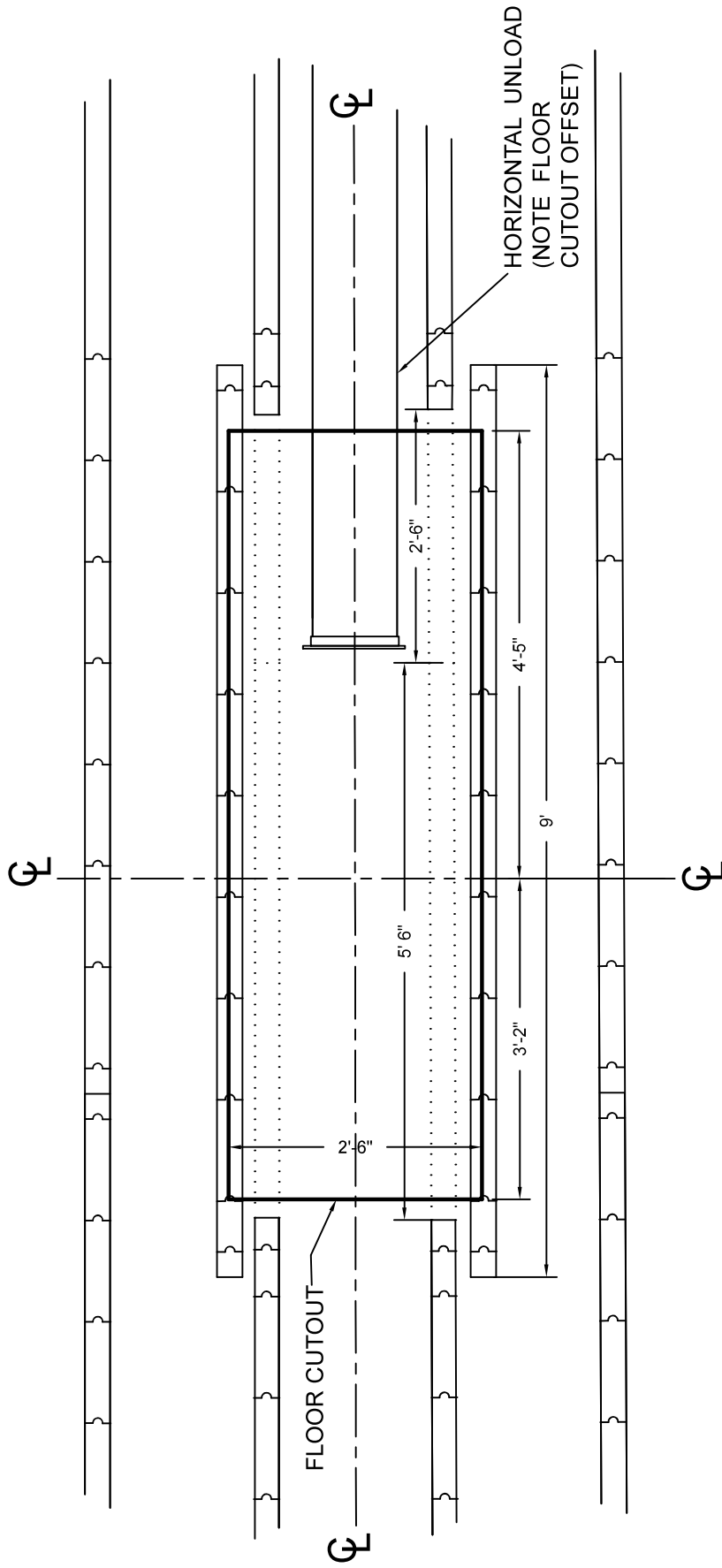

NOTE: PAGE INTENTIONALLY
LEFT BLANK

SHIVERS MANUFACTURING
614 W. English Street
Corydon, IA 50060
Ph. (641) 872-1005 ** Fax (641) 872-1593
www.shivers.com